

UNCLASSIFIED

AAEC/E 69

AUSTRALIAN ATOMIC ENERGY COMMISSION
RESEARCH ESTABLISHMENT
LUCAS HEIGHTS

STUDIES OF URANIUM-SODIUM SUSPENSIONS
PART I
CONSTRUCTION AND OPERATION OF
EXPERIMENTAL LOOP

by

F. L. BETT

R. J. HILDITCH

R. G. MEPHAM

T. N. KLUSS

Issued Sydney, August 1961



UNCLASSIFIED

AAEC/E 69

FOREWORD

This report describes part of the work carried out at the Lucas Heights Research Establishment on a liquid metal fuel reactor based on a dispersion of fissile material in sodium.

Research at Lucas Heights on the liquid metal system ceased in 1959. As this is therefore a complete report of discontinued work, a considerable amount of detailed description and discussion is presented, over and above that normal to a report on part only of a continuing project.

K. F. ALDER,
ACTING DIRECTOR.

17.5.61.

AUSTRALIAN ATOMIC ENERGY COMMISSION
RESEARCH ESTABLISHMENT
LUCAS HEIGHTS

STUDIES OF URANIUM--SODIUM SUSPENSIONS

PART I

CONSTRUCTION AND OPERATION OF
EXPERIMENTAL LOOP

by

F. L. BETT

R. J. HILDITCH

R. G. MEPHAM

T. N. KLUSS

ABSTRACT

An experimental uranium-sodium suspension loop has been operated for 4,320 hours at the A.A.E.C. Research Establishment. This report describes the design, construction, commissioning, and operation of the loop to the point where a complete stable suspension was obtained.

CONTENTS

	Page
1. INTRODUCTION	1
2. DESIGN AND CONSTRUCTION OF THE LOOP AND AUXILIARY CIRCUITS	1
3. CLEANING AND VACUUM TESTING	8
4. SODIUM LOOP START-UP PROCEDURES	8
5. DETAILS OF SODIUM LOOP RUNS	9
6. ADDITION OF URANIUM POWDER TO THE LOOP SODIUM	10
7. SUMMARY	11
8. REFERENCES	11
9. ACKNOWLEDGMENTS	11

Figure 1 Dimensioned sketch of uranium – sodium suspension loop

Figure 2 Details of sodium filling circuit

Figure 3 Detail of vent tank top plate and attachment for taking samples and adding calcium to the loop while the sodium is at temperature and under argon pressure.

Figure 4 Vacuum, argon, air and water piping for uranium – sodium suspension loop.

Figure 5 Heaters and thermocouple location details

Figure 6 Dump valve block air heater

Figure 7 Control circuit

Figure 8 Argon purifier circuit

Figure 8a Argon purification unit (Photograph)

Figure 9 Apparatus for adding calcium to dump tank

Figure 10 Radiograph showing position of uranium slug in the vent tank

Figure 11 Apparatus for viewing and cleaning specimens and sodium samples under vacuum or argon

Figure 12 Apparatus for the transfer of uranium specimen from loop to sealed polythene storage container

Figure 13 Apparatus for visual observation of uranium powder

*Figure 14 Radiograph showing uranium on shoulders of vent tank

*Figure 15 Radiograph showing vent tank shoulders with uranium removed by tapping

*Figure 16 Radiograph of loop bottom

(Continued)

CONTENTS (continued)

*Figure 17 Radiographs showing uranium container (a) before and (b) after adding the powder to the loop

*Figure 18 Close up of loop in enclosure (Photograph)

*Figure 19 Overall view of loop enclosure (Photograph)

* Figures not referred to specifically in text

APPENDIX 1 ELECTROMAGNETIC PUMP DETAILS

APPENDIX 2 DETAILS OF HEATERS

APPENDIX 3 PREPARATION OF HIGH-PURITY SODIUM

Figure 1 A.E.R.E. type vacuum distillation unit for sodium purification

Figure 2 Sodium purification apparatus (Photograph)

APPENDIX 4 OPERATING EXPERIENCE WITH THE LOOP

1. INTRODUCTION

The initial research programme of the Australian Atomic Energy Commission called for investigation of two thermal reactor systems; one cooled and fuelled by a suspension of micron sized uranium powder in liquid sodium; the second employing heterogeneous solid fuel elements cooled by a gas. Work carried out on the first of these two systems to investigate some aspects of suspension behaviour is described in this report (Part 1) and AAEC/E 70 (Part 2).

Early work by Alder and Bett (unpublished) established that:

- (i) sodium must be above about 400°C to wet and permit dispersion of fine uranium powder,
- (ii) suspension of this powder would require velocities only obtainable in a pumped system,
- (iii) suspension was not possible unless the powder was completely wetted by the liquid sodium,
- (iv) in multi-velocity systems where some velocities were lower than the suspension velocity, wetted uranium powder accumulated in the low velocity areas of the system, and
- (v) oxygen level in the sodium must be extremely low for the sodium to be compatible with uranium.

To verify some of the conclusions reached by Cairns et al. (1957/8) from analogue studies and to investigate metallurgical phenomena expected to be associated with the sodium/uranium/container material system, a simple pumped loop system for circulation of a uranium/sodium suspension was constructed and operated. The loop was constructed from 18/8/1 austenitic stainless steel, the sodium was chemically treated and vacuum distilled and the uranium was clean micron sized powder prepared by the hydride route, Kelly (unpublished).

This report describes the design, construction, commissioning, and operation of this experimental loop.

2. DESIGN AND CONSTRUCTION OF THE LOOP AND AUXILIARY CIRCUITS

2.1 Design and Construction of the Loop

The following loop design criteria were deduced from the early experiments already mentioned and technical considerations:-

- (1) A liquid metal pump should be included to produce sufficiently high fluid velocities to allow suspension of the uranium powder. A flowmeter to measure suspension velocities was also necessary.
- (2) Because of the expected difficulty in maintaining suspension* and the desirability of uniform conditions in the loop, the internal contours of the loop were to be free of obstructions and such that minimum local velocities should not differ greatly from the ruling suspension velocity.
- (3) Facilities for filling, dumping, sampling, addition of uranium samples and getters, and operation under controlled atmospheres should be available.

*Chemical Engineering Handbook (Perry, 1950) defines easily suspendable slurries as having density differences, solid:liquid of 2:1 maximum and slurries difficult to suspend as having density differences, solid:liquid of 4:1 and over. The ratio for uranium and sodium is approximately 19:1.

- (4) As radiographic (and later radiometric) techniques were to be used in following the suspension behaviour, radiation attenuation in structural material should be minimised.
- (5) For safety, convenience, and staffing, the loop was to be as small as possible and capable of automatic controlled operation.

A choice could be made between vertical and horizontal disposition of the loop and between tight and gradual pipe bends. As a vertically disposed loop incorporates both horizontal and vertical limbs with vertical flow both assisted and retarded by gravity, it was selected in preference to a horizontally disposed loop. A compromise on pipe bends was adopted. Abrupt bends were expected to cause gross velocity inhomogeneities while slow bends would increase the size of the loop.

The physical size of the loop was dictated by the size of the liquid metal pump and the minimum radius to which the tube selected for the loop could be bent. The pump, an A.C. conduction unit of 10 g.p.m. capacity, (see Appendix 1) was taken with the flowmeter from a used rig. The pipe size of the pump and flowmeter was 0.75 inch I.D. This pipe size gave a maximum theoretical flow velocity well in excess of the figure expected to be necessary for complete suspension, 2.7 ft./sec. (Cairns et al. 1957/8), and was relatively easy to fabricate to the desired standard.

Consequently the loop was constructed of this pipe viz: 0.75 inch I.D. x 16 s.w.g. 18/8/1 stainless steel fully softened and descaled to B.S. T.55. The minimum radius to which this pipe could be smoothly bent was 12 inches and this, plus the dimensions of the pump determined the final loop dimensions. (Figure 1). (N.B. all parts of the loop which might contact sodium were made from 18/8/1 stabilised stainless steel to B.S. T.55 or B.S. 1501.821B).

The gauge of pipe was the lightest available. Asbestos and slag wool were used for thermal insulation and the normal steel insulation cover was dispensed with. Beaded Nichrome heaters were used in place of metal sheathed Nichrome heaters. By these means radiation attenuation was minimised.

To allow for thermal expansion of the sodium during operation and also to provide a space for free access to the sodium for sampling, uranium addition, and compatibility experiments, a vent tank was fitted to the top of the loop. It was realised that this vent tank would be a region of velocity inhomogeneity because of its large diameter and would favour precipitation of uranium from suspension. To counteract this effect the slope of the walls was made 45 degrees so that any deposits of powder could be washed down into the loop by the movement of the sodium in the vent tank. No information was available on the rest angle of fine uranium powder in liquid sodium and the figure of 45 degrees was selected arbitrarily.

A large diameter air cooled flange was welded to the top of the vent tank. An air cooled top plate was then clamped to this over an "O" ring seal.

The flange and top plate were made large so that the "O" ring seal could be cooled without cooling the top of the vent tank below 100°C and so causing sodium condensation. As an aid to operation of the loop, particularly during filling, two windows were fitted to the top plate, a movable cover slide being also fitted via a Wilson seal to prevent direct sodium condensation onto the windows when they were not being used. A 1 inch I.D. stainless steel pipe stub was also welded to the top plate to act as a vacuum/argon port as well as a vehicle for sampling, uranium addition, and compatibility testing.

Entry of sodium to the loop was through a valve welded to the lowest point of the loop. A freeze seal liquid metal valve was modified for the purpose, the valve seat block and connection pipe being reduced in size so that when welded onto the loop the face of the poppet was aligned with the inner wall of the loop, leaving only a very small annular dead space around the poppet. The valve block and stem were fitted with air heater/coolers to assist in either melting or freezing the sodium seal as operation demanded. The poppet was stellite on its seating face to prevent welding together of the poppet and seat under operating conditions. Operation of the valve was remotely controlled by means of a chain drive and hand wheel situated outside the enclosure containing the loop.

The loop with flowmeter, pump, vent tank, valve, and connecting plate was mounted in a framework of $\frac{3}{4}$ inch I.D. galvanised iron pipe secured by screwed fittings. To help contain sodium in the event of a loop failure the assembly was placed in a steel tray divided into compartments and of a volume equal to four times that of the sodium in the loop.

All welding was done by the argon backed straight polarity T.I.G. process to ensure clean smooth internal surfaces and high quality welds. Weld preparation consisted of square edge closed butt for all pipes and square edge fusion for flange attachment. Pre-weld cleaning was by etching or dry machining. Welds were tested by radiography, pressure testing to 50 p.s.i.g. and leak testing with soap solution, and finally by vacuum testing to 10^{-3} mm Hg with a permissible leak rate of 2 microns in 24 hours.

2.2 Design and Construction of Loop Filling Circuit

Sodium was forced up into the loop from below, the loop having previously been evacuated and the sodium dump tank pressurised. The rate of flow from the supply tank was controlled by the pressure differential and the valve at the bottom of the loop. The loop was emptied (i.e. the sodium dumped) by opening the valve and completing a connection between the loop vent tank and the top of the dump tank to allow pressure equalisation between these two vessels.

As it was planned to deoxidise the sodium by equilibration with calcium at 350°C in the dump tank, the flange and lid of this vessel were fitted with water cooling pipes and a teflon "O" ring. An access port with modified ball valve (Bett and Kluss, 1960) was fitted to the lid of the dump tank for use in sampling and calcium addition.

As the sodium was filtered before adding it to the dump tank, a filling tank was necessary before the dump tank. This contained a steel wool or stainless steel gauze filter element in its base. Connections between the tanks and the loop were made by demountable water cooled "O" ring sealed junction plates. The arrangement of the filling circuit is shown in Figure 2.

2.3 Sampling

2.3.1 Sampling Apparatus

The design of the rig allowed for sampling of the loop sodium for chemical analysis, the removal of sodium from the loop to reduce the level in the vent tank, the insertion of specimens into the sodium stream for compatibility studies, and the addition of gettering material to the sodium. These operations were carried out without contaminating the purified sodium while the loop was operating at a sodium temperature of 500°C with a purified argon atmosphere at a pressure of 10 p.s.i.g.

The sampling apparatus is shown in Figure 3. The sample was moved in and out of the sodium by a $\frac{1}{4}$ inch diameter silver steel rod three feet long. This rod passed through a $\frac{1}{4}$ inch Wilson seal. The two modified ball valves (Bett and Kluss, 1960) were attached, one to the loop top plate, the other to the sampling chamber. Between the two valves a vacuum/argon line enabled the adjustment of conditions in the sample vacuum chamber to match those in the loop before opening the bottom ball valve.

The specimen basket and sample pot were fabricated from stainless steel mesh and tubing respectively. They were suspended by Nichrome ribbon, spot welded to a stainless steel nut firmly held on the screwed end of the $\frac{1}{4}$ inch diameter push rod by a lock nut.

The parts of this rig were cleaned as described in Section 3.

2.3.2 Sampling Procedure

After pickling, washing, and drying, the sample pot was placed in the sample vacuum chamber which was then evacuated and filled with argon. The sampling rig was fitted into position on the loop and the volume between the two ball valves was also evacuated and filled with argon. The pressures in the sample vacuum chamber, the volume between the two ball valves, and the loop, were equalised, the bottom ball valve opened, and the sample pot pushed into the loop atmosphere.

The sample pot was suspended just above the sodium surface for 10 minutes until it became preheated. It was then lowered to the required depth below the sodium surface. The final position of the sample pot was checked by radiography. The sample was raised from the sodium and left hanging near the bottom ball valve for 15 minutes until the sodium cooled below 100° C. It was then withdrawn through the valves. This procedure was necessary to avoid molten sodium sticking to the bore of the ball valve and interfering with its operation.

The sampling apparatus containing the sample was removed at the 1 inch vacuum coupling after closing the two ball valves, and then transferred to the sample viewing chamber. The sample was pushed into this chamber through two ball valves and stored under vacuum or purified argon.

Before using the sampling rig again, the section of 1 inch diameter copper tubing between the bottom ball valve and the dismantling point at the 1 inch vacuum coupling was cleaned by swabbing with small quantities of ethyl alcohol absorbed in a cloth to remove sodium. The alcohol was then removed by evacuation. Repetition of this procedure resulted in satisfactory cleaning of the re-entrant corners around the ball in the valve.

2.4 Vacuum/Argon Circuit

The vacuum circuit was designed to evacuate the loop, dump tank, all argon lines, and sampling apparatus either as one unit or individually through a system of valves. A vacuum unit consisting of a 150 litre/minute rotary backing pump with a 2 inch oil diffusion pump proved to have adequate capacity to give the desired final vacuum of 10⁻³ mm of Hg. This unit was mounted well away from the loop so that it would not be contacted by sodium in case of a leak and would allow easy access to the loop. Pirani vacuum gauges and Bourdon type pressure/vacuum gauges were connected at the points shown in Figure 4 which details the vacuum/argon circuit.

Purified argon was used as a protective atmosphere over the sodium in the loop and dump tank and also in the sampling apparatus.

When the loop was operating and the sodium flowing under the argon cover the vacuum unit was only used to reduce the pressure build-up in the loop when increasing the sodium temperature. The argon pressure was limited to a maximum of 10 p.s.i.g.

The vacuum pipe work was constructed from 2 inch, 1 inch, and ¼ inch diameter copper tubing to B.S. 659 silver soldered to Yorkshire fittings. Bellows sealed diaphragm valves were used in the argon and vacuum lines.

The filling tank was evacuated by a separate vacuum unit and filled with argon from an independent source.

2.5 Heater Circuit and Thermocouples

2.5.1 Heaters

The main loop heaters were wound directly onto the loop using ceramic bead insulated Nichrome wire. They were thermally insulated by glass wool sleeves and asbestos.

The auxiliary heaters were made from a variety of proprietary resistance heating units but special heaters such as the dump valve block air heater were specially wound from Pyro-tenax heating cable which was directly exposed to the air stream (see Figure 6). This heater was sufficient to raise the dump valve block temperature to 200°C in 1 minute if required for rapid dumping. Propane burners were used for occasional heating if required.

The ratings of the various heaters are listed in Appendix 2 and their location is shown in Figure 5.

2.5.2 Thermocouples

Chromel/alumel thermocouple wires insulated by glass fibre covering were used to measure the temperatures at the points indicated in Figure 5. The thermocouples at points 4, 5, 6 and 7 measured a temperature on the outside surface of the stainless steel tubing. The ceramic bead insulation of the loop winding kept the hot junctions of the thermocouple from close contact with the heater windings. Projecting sleeves into the sodium stream were not used as they would have caused flow disturbances in the loop.

Thermocouple point 7, i.e. right hand top loop, was connected to a proportional temperature controller, which controlled the on/off time of the main loop heaters. The thermocouples located at points 1, 2, 3 (vent tank), 4, 5, and 6 (loop) were connected to a six point temperature recorder.

Thermocouple point 8 measured the temperature of the electromagnetic pump windings. The primary pump winding could be operated up to 180°C and was air cooled so that its outside temperature measured by the thermocouple at point 8 did not rise above 80°C with sodium temperatures of up to 600°C. The windings appeared to be in good condition when examined on dismantling the loop.

The temperature of the electromagnetic flowmeter magnet was recorded when measuring the flowmeter e.m.f. so that allowance could be made for magnet flux variation with temperature.

2.5.3 Maximum Error Possible in Temperature Measurements

The following analysis was made by the method of Almond (1960).

The typical thermocouple circuit used was that shown in Figure 5a.

The following standard guarantees of chromel/alumel thermocouple wire were used to calculate the maximum error possible in the temperature measurements:

	<u>Guarantee</u>		<u>Temperature range</u>			
Thermocouple wire	± 2° C		- 18° C to 280° C			
Extension wire	± ¼ per cent.		> 280° C			
	± 2° C		- 18° C to 205° C			
	<u>Errors in °C</u>					
<u>Temp. Indicated</u>	<u>T/C</u>		<u>Extn.</u>		<u>Total</u>	
	<u>H/J</u>	<u>C/J</u>	<u>T/C</u>	<u>Inst.</u>	<u>Inst.</u>	<u>°C</u>
300° C	3	2	2	2	½	9½
400° C	3¾	2	2	2	½	10¼
500° C	4½	2	2	2	½	11
600° C	5½	2	2	2	½	11¾

This analysis shows that maximum possible errors in the temperature indicated are:--

300°C ± 9½°C

400°C ± 10¼°C

500°C ± 11°C

600°C ± 11¾°C

2.6 Control and Safety Circuits

2.6.1 General

As the loop was operated on a one shift basis and left unattended at night and at week-ends, the control system shown in Figure 7 was designed to:

- (a) cut off power to the loop in case of fire, ring an alarm bell at the guardhouse and thus alert site fire fighting services,
- (b) cut off the power to the loop, if the sodium flow rate dropped below a selected minimum value, and
- (c) regulate the input power to the loop heaters to maintain the desired temperature.

2.6.2 Fire Alarm Circuit

An ionisation smoke sensing device was fitted above the loop. This consisted of an open ionisation chamber in which the air was made conducting by alpha particles emitted from a small quantity of radium. Sodium oxide vapour or any other suspension of particles in the chamber air changed its conductivity, thus upsetting a balanced potential bridge and activating relays which were used to operate the fire alarm bell and to cut off all electrical power input to the loop.

The relay operated a parallel alarm circuit in the guardhouse which served to alert the fire fighting service.

2.6.3 Flow Control

The e.m.f. generated by the electromagnetic flow meter was fed to an electronic recorder/controller. It was arranged that if the flow decreased below any preselected fraction of that required, the controller cut off the power to the loop. Reduction of flow could be caused by plugging, leakage of sodium from the loop, or heater winding failure.

2.6.4 Temperature Control

The chromel/alumel thermocouple attached to the top right hand side of the loop was used to control the power input to the top and bottom loop heaters, the vent tank heater, and the top and bottom loop heaters. The temperatures at the following points on the loop with the temperature controller set at 300°C are indicated below:

Top of vent tank	99°C
Middle of vent tank	273°C
Bottom of vent tank	291°C
Top L.H.S. loop	291°C
Bottom L.H.S. loop	296°C
Bottom R.H.S. loop	297°C

If the thermocouple controlling the power input to the loop burnt out, the thermocouple break protection circuit in the temperature controller would cause full scale deflection of the control pointer and the power to the loop heaters would be cut off. This would result in the sodium cooling to a temperature at which the flow would be reduced to a value below the control point and the flow controller would cut off the power supply to the rest of the electrical components of the loop. Similarly failure of the loop heater windings would result in cooling of the sodium and a reduction in flow.

The overall operation of the control system was checked periodically by introducing smoke into the loop enclosure. The e.m.f. output of the electromagnetic flowmeter and thermocouples was measured with a potentiometer at regular intervals and compared with that indicated by the control instruments.

2.7 Cooling Circuits

Compressed air was used to cool the top plate of the vent tank, the dump valve block and stem, the flowmeter magnet, and the electro-magnetic pump windings, while the dump tank cover plate and the junction plate between the dump tank and the filling tank were water cooled (Figure 4).

The dump valve air cooling stream was directed onto the dump valve block and stem. The dump valve block air stream provided heated air during start-up. The valve stem was cooled to prevent sodium leaking past the spindle to the copper bellows. The valve block temperature reached 165°C during operation.

The temperature of the flowmeter magnet poles was kept below 80°C by blowing air on the top and bottom of the poles. The base of the magnet was also cooled to restrict changes in the gap length by expansion.

The pump windings were air cooled to prevent overheating of the class H insulating materials used in the primary windings. The winding temperature increased to a maximum of 80°C during the high temperature run, when the sodium temperature reached 600°C.

The "O" ring seals on the dump tank top plate and the junction plate between the dump tank and the filling tank were water cooled by recirculated water passing through copper tubing soft soldered to the plate and flange adjacent to the "O" ring groove and to the dump tank side of the junction plate.

2.8 Argon Purification

To preserve sodium purity, atmospheres of either vacuum or purified argon were used in contact with sodium.

Argon was purified by the method recommended by Smith and Sheridan (1957) and the apparatus is shown in Figures 8 and 8a.

2.9 Feed Sodium Purification

Two grades of sodium were used in the loop depending on the purpose of the particular loop run. In the first loop-cleaning run, filtered commercial brick sodium was used as it contained more sodium oxide than the highly purified metal and therefore would have a greater cleaning action.

In subsequent runs, where the highest possible sodium purity was required, vacuum melting, hydrogen dechlorination, low temperature filtration, calcium deoxidation, and vacuum distillation were used to purify the loop feed sodium. These processes are described in more detail in Appendix 3.

3. CLEANING AND VACUUM TESTING

The loop, dump tank, and filling tank were cleaned by pickling with 15 per cent. HNO_3 - 4 per cent. HF - bal. H_2O mixture, washing and drying, and then evacuating individually to 10^{-3} mm Hg. The leak rate of 2 microns in 24 hours was achieved after modifying the ball valves and liquid metal valves (Bett and Kluss, 1960). The components were assembled in stages and each joint was checked for vacuum tightness before adding another piece. When the loop was fully assembled, its temperature was increased gradually to 300°C while being evacuated and, after prolonged pumping, the above vacuum specifications were achieved. The final clean-up of the loop consisted of operation with filtered brick sodium for 162 hours at 500°C .

4. SODIUM LOOP START-UP PROCEDURES

The operations in the start-up procedure were as follows:

- (1) Evacuate loop to 10^{-3} mm Hg.
- (2) Check cooling-air velocity to vent tank top plate and electromagnetic pump windings.
- (3) Preheat loop at 300°C for 24 hours.
- (4) Check cooling water to dump-tank top plate.
- (5) Heat sodium in dump tank to 250°C .
- (6) Turn on (a) dump valve block air heater,
(b) flowmeter venturi heater, and
(c) transfer-pipe heaters.
- (7) Preheat electromagnetic pump channel by passing current through primary winding (40V, 1.0A) for $1\frac{1}{2}$ hours.
- (8) Fill loop with purified argon to atmospheric pressure.
- (9) Pressurise dump tank to 100 mm Hg above loop pressure.
- (10) Open dump valve.
- (11) Wait for sodium to appear at required height in vent tank. Follow the progress of sodium into the loop by temperature chart changes and flowmeter readings. Adjust the final heights in the loop by increasing or decreasing the pressure difference between dump tank and loop.
- (12) Close dump valve and turn off dump valve air heater. Leave air flowing to freeze sodium in dump valve.
- (13) Open switches to all auxiliary heaters and turn off air supply to flowmeter venturi tube.
- (14) Check cooling-air velocity to dump valve block, vent tank top plate, flowmeter magnet, and electromagnetic pump windings.
- (15) Increase electromagnetic pump volts to 100 and check flowmeter readings and temperatures indicated at the various positions around loop.

5. DETAILS OF SODIUM LOOP RUNS

The first charge of sodium in the loop was required to carry out bulk cleaning of the internal surfaces of the stainless steel container material. Sodium containing oxide was considered more corrosive and therefore more useful than highly purified sodium for removing the gross contamination remaining in the loop, so filtered sodium (containing oxide) was charged and circulated for 162 hours at 500°C. This sodium was dumped and discarded at the end of the run.

The sodium remaining in the loop after the first run was diluted with a subsequent charge of sodium of lower oxygen content prepared by filtration and distillation. This second charge was discarded after circulating for 52 hours.

Subsequent charges of sodium were prepared as described in Appendix 3. Full details of loop runs are given in Table 1.

TABLE 1

Details of Sodium Loop Runs

Run No.	Date of start-up	Total hours sodium circulating	Sodium clean-up details	Remarks
1	22.5.59	162	Filtered brick sodium	Final cleaning of s.s. container material. Sodium discarded at end of run.
2	8.7.59	52	Filtered, distilled	Sodium discarded at end of run.
3	11.8.59	6	Calcium added to still filling chamber, hydrogen bubbled through charge in filling chamber, filtered, distilled	Sodium analysis Ca .036 per cent. Cl < 1 p.p.m. Sodium returned to dump tank at end of run.
4	18.8.59	67	As for run 3 plus digesting with calcium in dump tank for 70 hours at 150°C, 30 hours at 250°C. 24 g calcium added (see Figure 9)	Sodium returned to dump tank at end of run.
5	28.8.59	51	As for run 4. No further getter added to dump tank but Na and Ca present. Heated in dump tank for 120 hours at 350°C, 50 hours at 250°C	Sodium returned to dump tank at end of run.
6	31.8.59	92	As for run 5	Sodium returned to dump tank at end of run.

. . . Table 1 continued

TABLE 1 (Continued)

Run No.	Date of start-up	Total hours sodium circulating	Sodium clean-up details	Remarks
7	7.9.59	3,800	<p>As for run 6 plus loop additions of calcium. 7.9.59 - 4 g of calcium added.</p> <p>Heated in dump tank for: 17½ hours at 210°C 2½ hours at 235°C 3½ hours at 260°C 25½ hours at 290°C</p> <p>10.9.59 - 4 g of calcium added. Heated for: 23 hours at 290°C</p>	<p>Sodium analysis 1.27 per cent. Ca. < 1 p.p.m. Cl</p> <p>This sodium was used for the loop experiments with uranium powder.</p> <p>< 1 p.p.m. O</p>

6. ADDITION OF URANIUM POWDER TO THE LOOP SODIUM

Before adding the uranium powder to the loop sodium, a small slug of uranium 1 inch long and 3/8 inch diameter was placed in the loop. The radiograph in Figure 10 shows the position of the slug in the vent tank. After 100 hours at 300°C, the slug was transferred to the viewing chamber (Figure 11) and leached twice with absolute ethyl alcohol under a stream of argon and then sealed in a polythene container (Figure 12).

The surface of the specimen was examined by microscope and by x-ray diffraction. Surface oxide contamination of the uranium was not detected by either of these means. This test indicated that the oxygen level in the sodium was so low that detectable oxidation of uranium would not occur.

Early experiments (Section 1) had shown that uranium powder could only be submerged in and distributed through liquid sodium, if it was wetted by the liquid metal. The wetting temperature for high purity sodium on clean uranium is 387°C (Taylor and Ford, 1955) and it was therefore decided to drop the uranium powder onto a clean sodium surface held at 400°C. In this way, after a slight delay due to the heating and wetting of the uranium powder, the powder would fall through the sodium surface and would then be rapidly distributed throughout the system by the moving sodium stream.

Before the uranium powder was added to the loop it was inspected visually in a glass container under argon to ensure that it did not contain any unreacted uranium or agglomerated lumps. Then with the loop sodium temperature raised to 400°C the powder was dropped onto the sodium surface. The following sequence gives details of the operations:-

- (1) The uranium powder container was detached from the uranium hydride/de-hydride furnace (Kelly, unpublished) and the furnace was sealed.
- (2) The container was connected to the all-glass viewing tube (Figure 13) and the powder was transferred under purified argon by opening the plunger valve. After examination the uranium powder was returned to the container by inverting the assembly.
- (3) The container was placed in position above the loop and attached by the 1 inch vacuum coupling.

- (4) The space between the plunger valve and the ball valve was evacuated and filled with purified argon.
- (5) The bottom ball valve was opened and the powder admitted to the loop by opening the plunger valve. The loop was vibrated during this operation to break up mounds of powder formed on the liquid surface and also to dislodge powder falling on the vent tank walls.

Progress of the addition was then followed by radiographic examination of the vent tank and of the top and bottom limbs of the loop. These radiographs showed no detectable uranium deposition in the loop, a noticeable deposit of uranium on the vent tank shoulders, and no uranium on the sodium surface.

It was apparent that the powder had dropped onto the sodium surface, spread, wetted, and then fallen into the sodium. Velocity conditions in the vent tank were such as to allow at least part of the powder to deposit on the shoulders of the tank where it remained, as the movement of the sodium was apparently insufficient to move it. The remainder of the powder was presumed to have entered the circulating fluid stream in the loop.

Vibration of the vent tank was used in an effort to move the uranium from the vent tank shoulders down into the loop. Radiographic examination after 30 minutes vibration showed that the deposit had been removed and also that no other deposits of uranium had formed in the loop. It was concluded from this evidence that the powder had all been absorbed into the circulating loop stream.

A second sample of powder was later added to produce the required concentration in the loop. Radiometric techniques were used (see Part 2 of this report) to follow the distribution of the uranium and the behaviour deduced from the first sample of powder was confirmed in detail.

63.9 grams of uranium powder of a nominal maximum diameter of 5 microns was added to the 800 grams of sodium in the loop in two batches and the resulting suspension was of 0.76 atomic per cent. uranium in sodium.

The addition of the powder to the sodium produced a reduction of approximately 5.4 per cent. in the flowmeter output e.m.f. from constant pump input voltage. This was caused by extra power being required to pump the suspension. This subject, together with hydrodynamic, metallurgical, and mechanical effects associated with the circulation of the suspension, is discussed in Part 2 of this report.

7. SUMMARY

This report has described the design, construction, commissioning, and operation of a small sodium uranium suspension loop to the point where a complete stable suspension was obtained.

8. REFERENCES

- Almond, J., 1960. Instrument and Control System 33 (1): 80-82.
- Bett, F.L., and Kluss, T.N., 1960. Demountable vacuum valves for use with liquid metals. Internal Report AAEC/TM43.
- Caims, R.C., and others. 1957/8. Studies of small particle suspensions for L.M.F.R., Parts I- VI. AAEC/E 5, 16, 17, 34, 37, 38.
- Smith, S.E., and Sheridan, M.B., 1957. Glove Box Symposium, A.E.R.E., February, 1957, Paper No. 17.
- Taylor, J.W., and Ford, S.D., 1955. Solid metal/liquid metal interaction studies Part II, Contact angle relationships of sodium on solids. AEREM/R 1729.

- ## 9. ACKNOWLEDGMENTS - To Mr. P. Gillespie for making radiographic examinations.

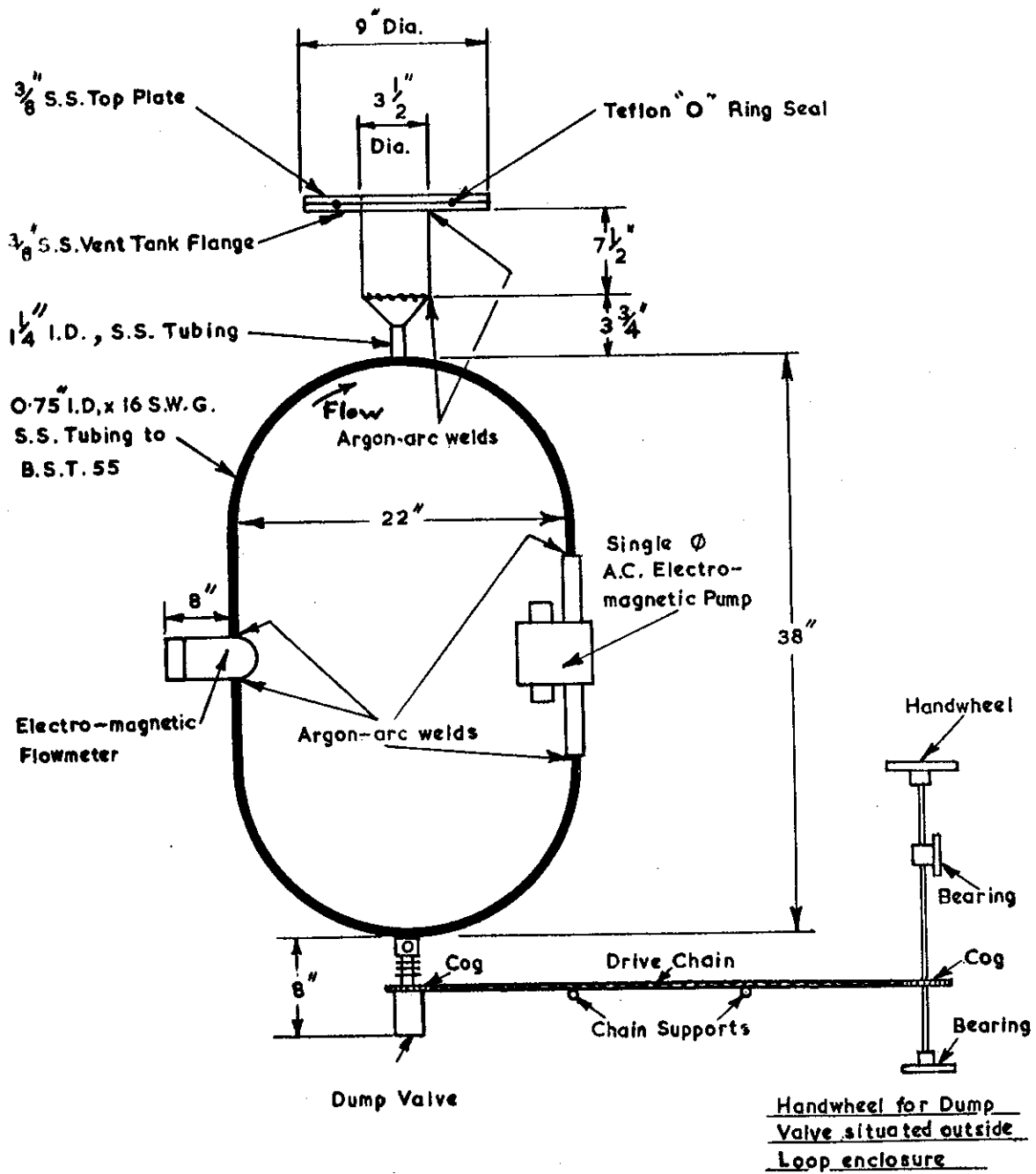
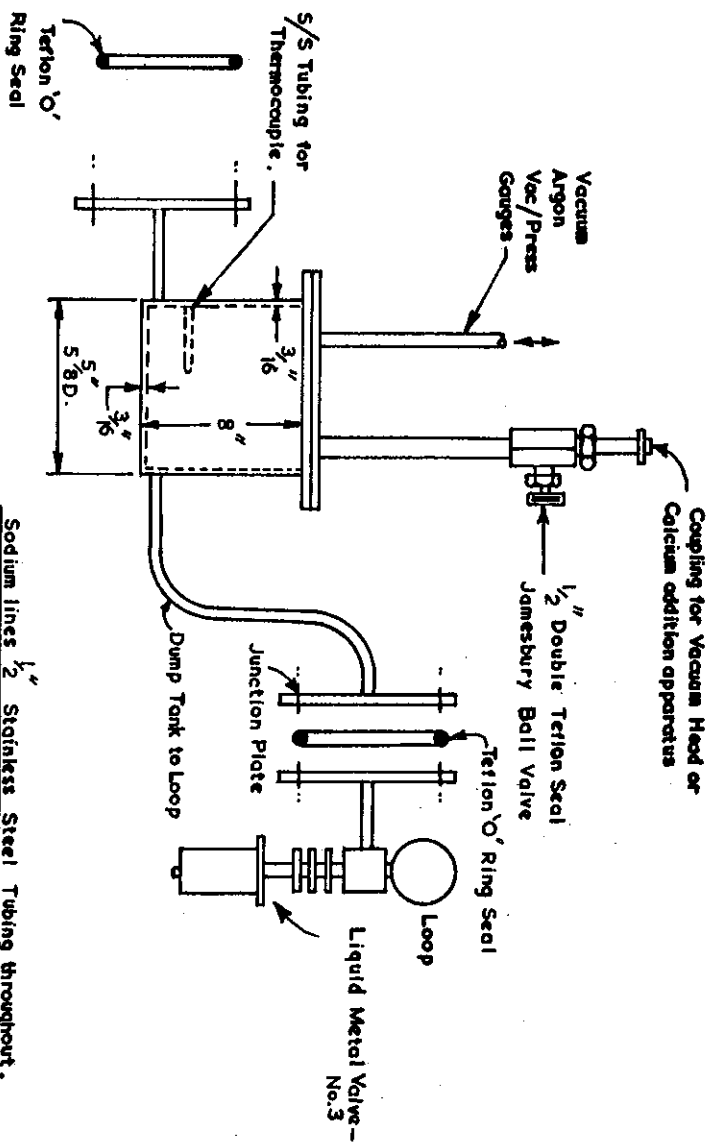
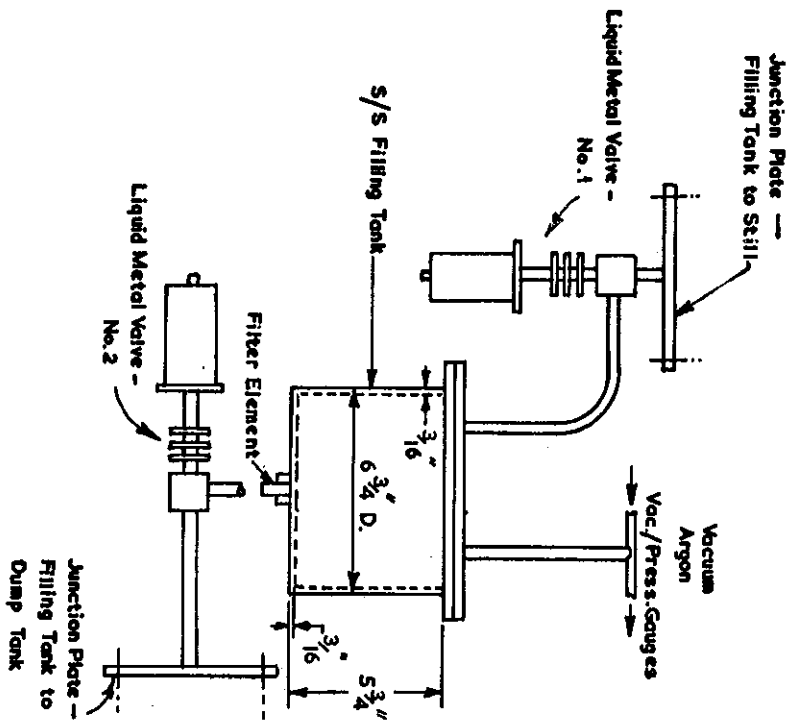

FIG. 1 DIMENSIONED SKETCH OF URANIUM-SODIUM SUSPENSION LOOP



Sodium lines $\frac{1}{2}$ " Stainless Steel Tubing throughout.
 Argon Arc welding where required.

FIG. 2 DETAILS OF SODIUM FILLING CIRCUIT

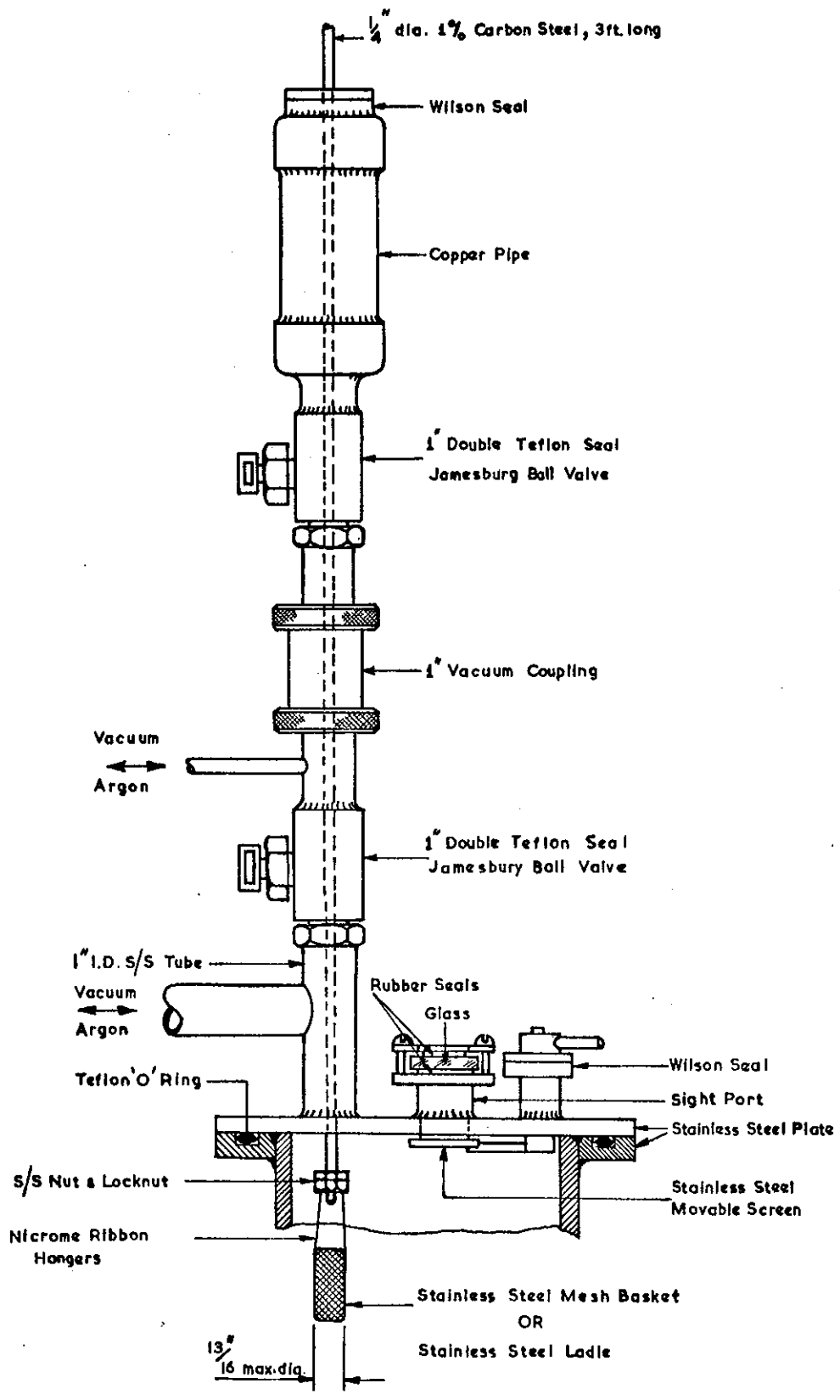
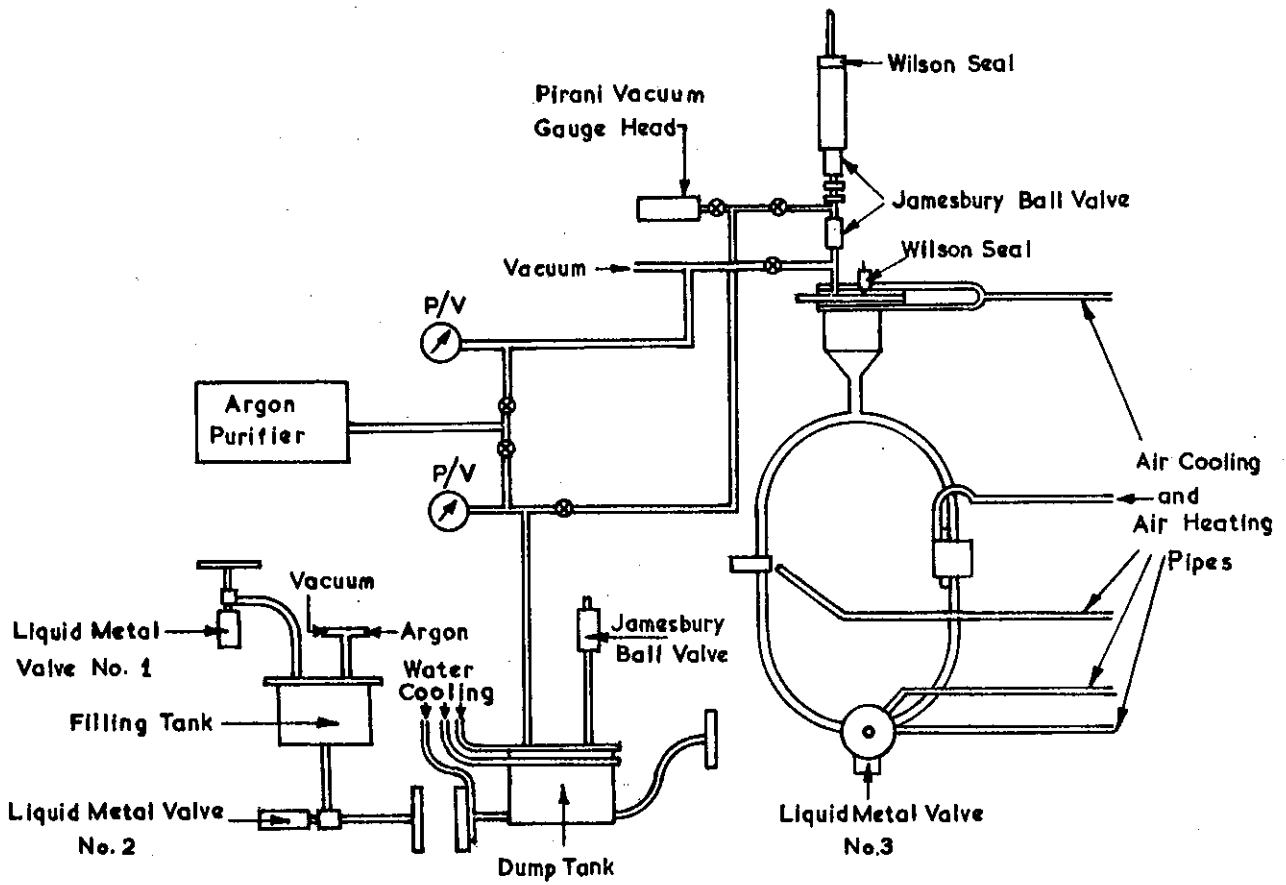

FIG. 3 DETAIL OF VENT TANK TOP PLATE AND ATTACHMENT FOR TAKING SAMPLES AND ADDING CALCIUM TO THE LOOP WHILE THE SODIUM IS AT TEMPERATURE AND UNDER ARGON PRESSURE.



● represents a Western Detail bellows valve or an Edwards diaphragm valve.

FIG. 4 VACUUM , ARGON , AIR AND WATER PIPING FOR URANIUM -SODIUM SUSPENSION LOOP

THERMOCOUPLE DETAILS

<u>T.C. No.</u>	<u>DETAILS</u>	
①	Top Vent Tank Temperature	} Connected to 6 point Indicator/Recorder.
②	Middle " "	
③	Bottom " "	
④	Top L.H. Loop " "	
⑤	Bottom L.H. Loop " "	
⑥	Bottom R.H. Loop " "	
⑦	Top R.H. Loop " "	Connected to Indicator/Controller
⑧	Electromagnetic Pump Winding Temp.	
⑨	Flow Meter Magnet Temp.	
⑩	Flow Meter Venturi Surface Temp.	
⑪	Sodium in Dump Tank Temp.	
⑫	Connecting Pipe Temp.	
⑬	Connecting Pipe Temp.	
⑭	Dump Valve Block Temp.	
⑮	Junction Plate Temp.	

TC's ⑨ — ⑮ connected to temperature Indicator through multi-point switch.

TC ⑧ connected to Indicator.

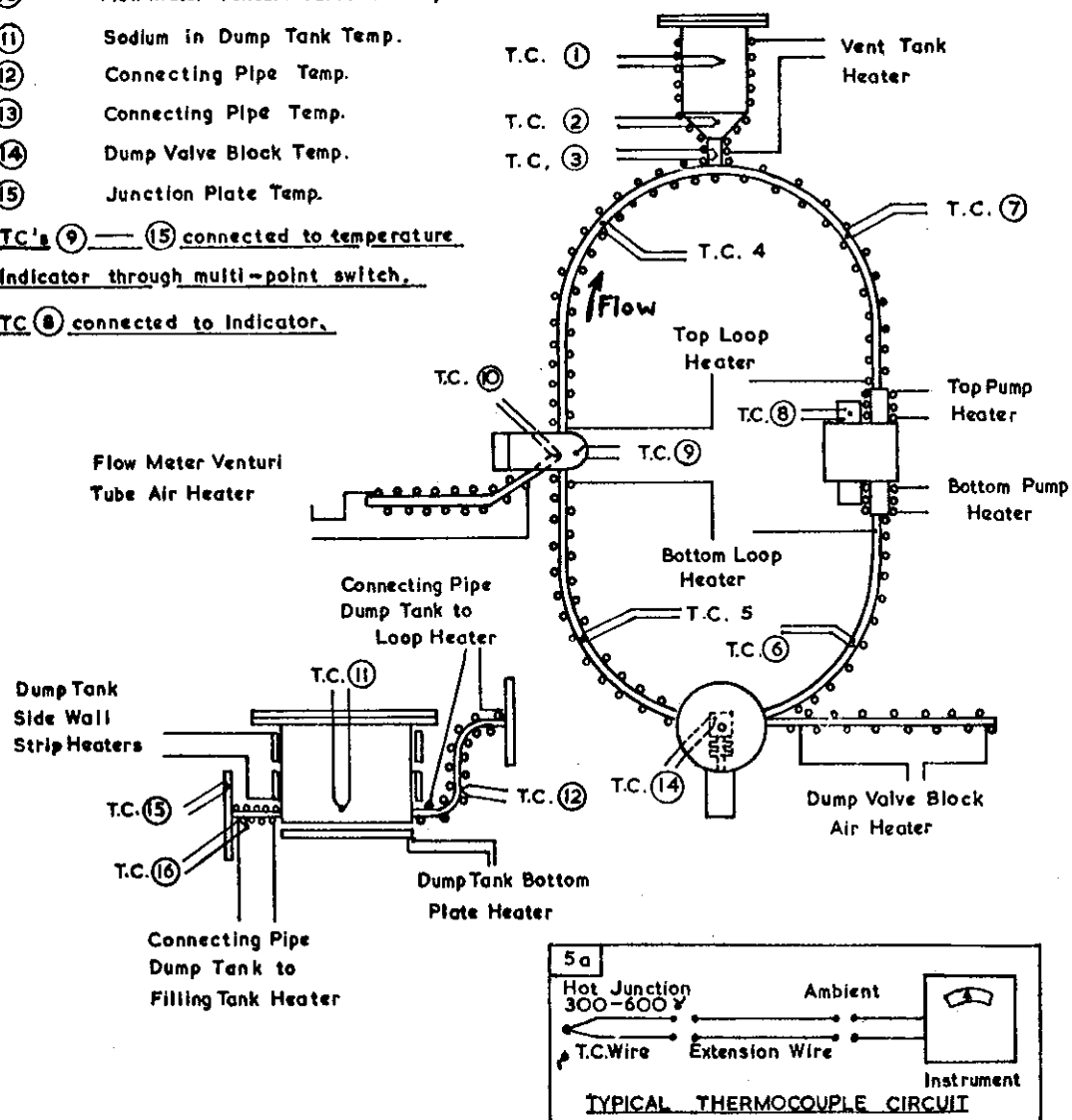

FIG.5 HEATERS AND THERMOCOUPLE LOCATION DETAILS.

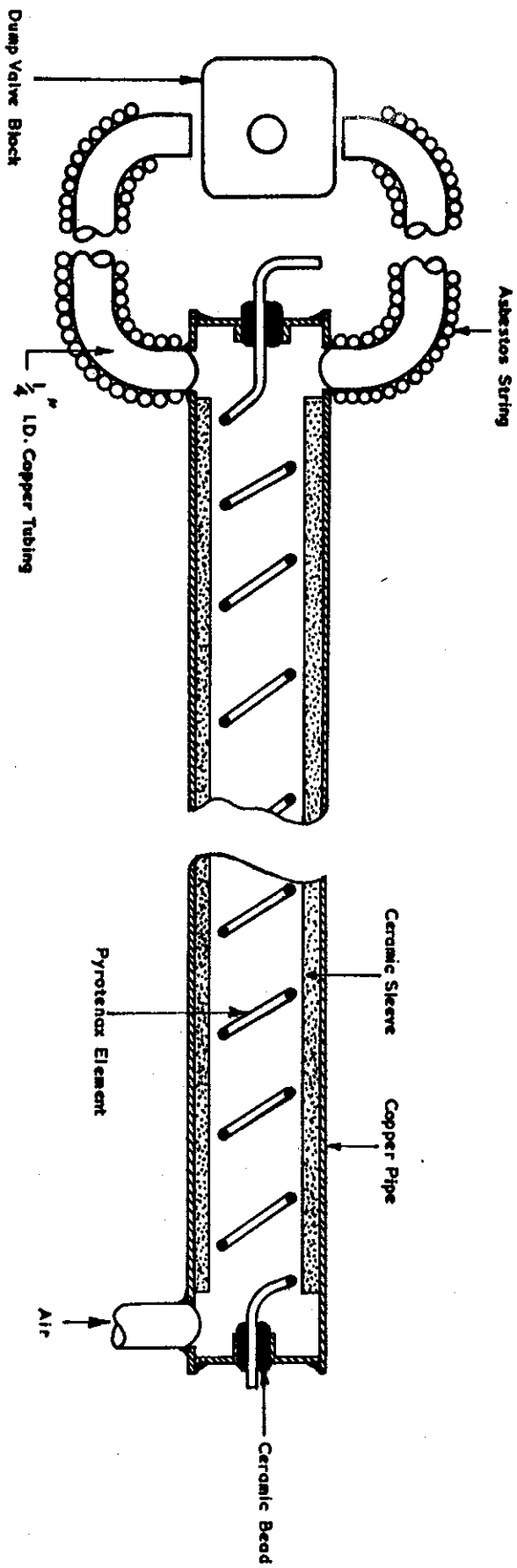

FIG. 6 DUMP VALVE BLOCK AIR HEATER. (ALSO FLOW METER VENTURI AIR HEATER)

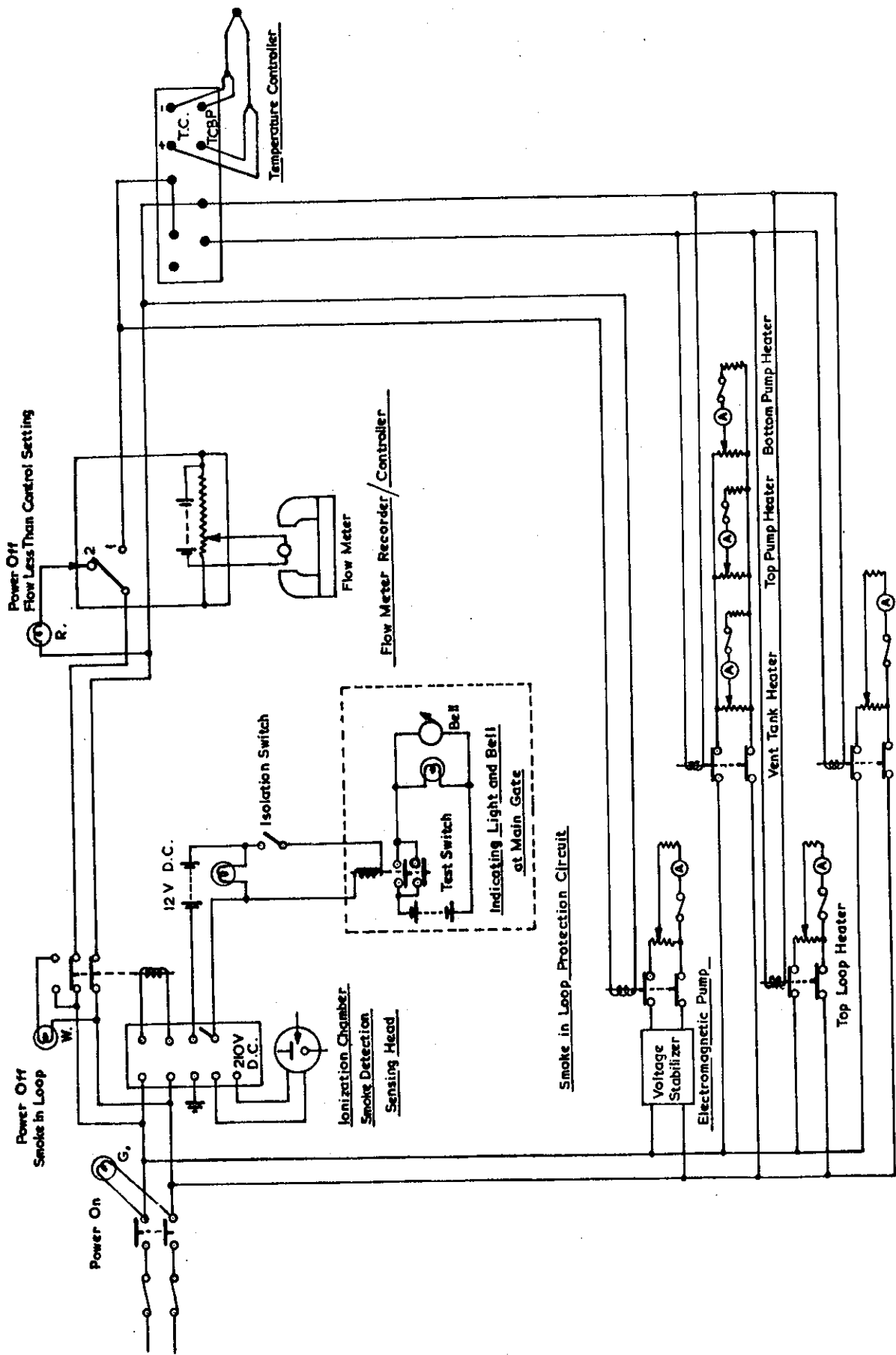

FIG. 7 CONTROL CIRCUIT

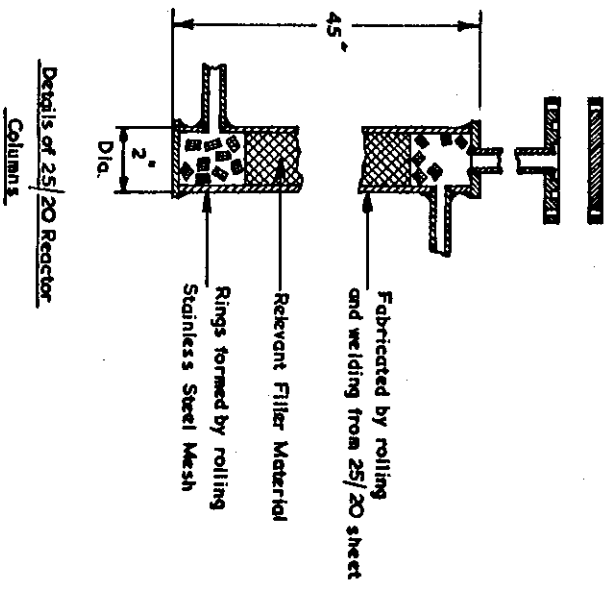
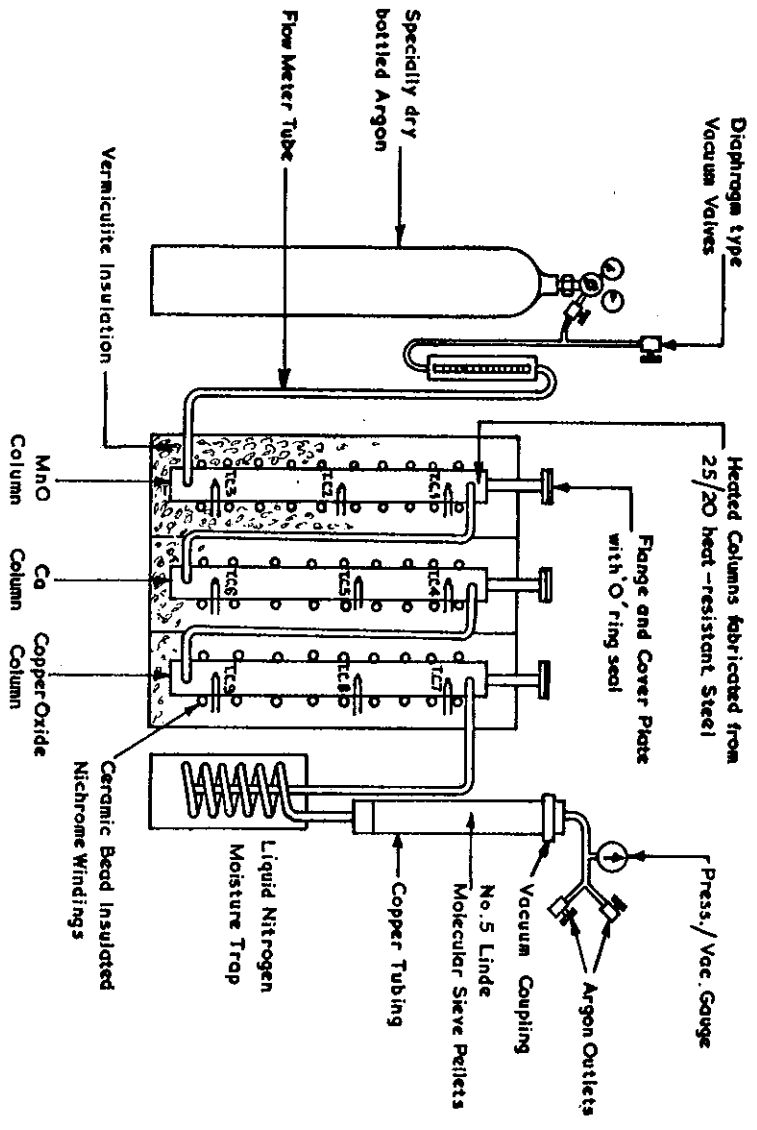

FIG. 8 ARGON PURIFIER CIRCUIT

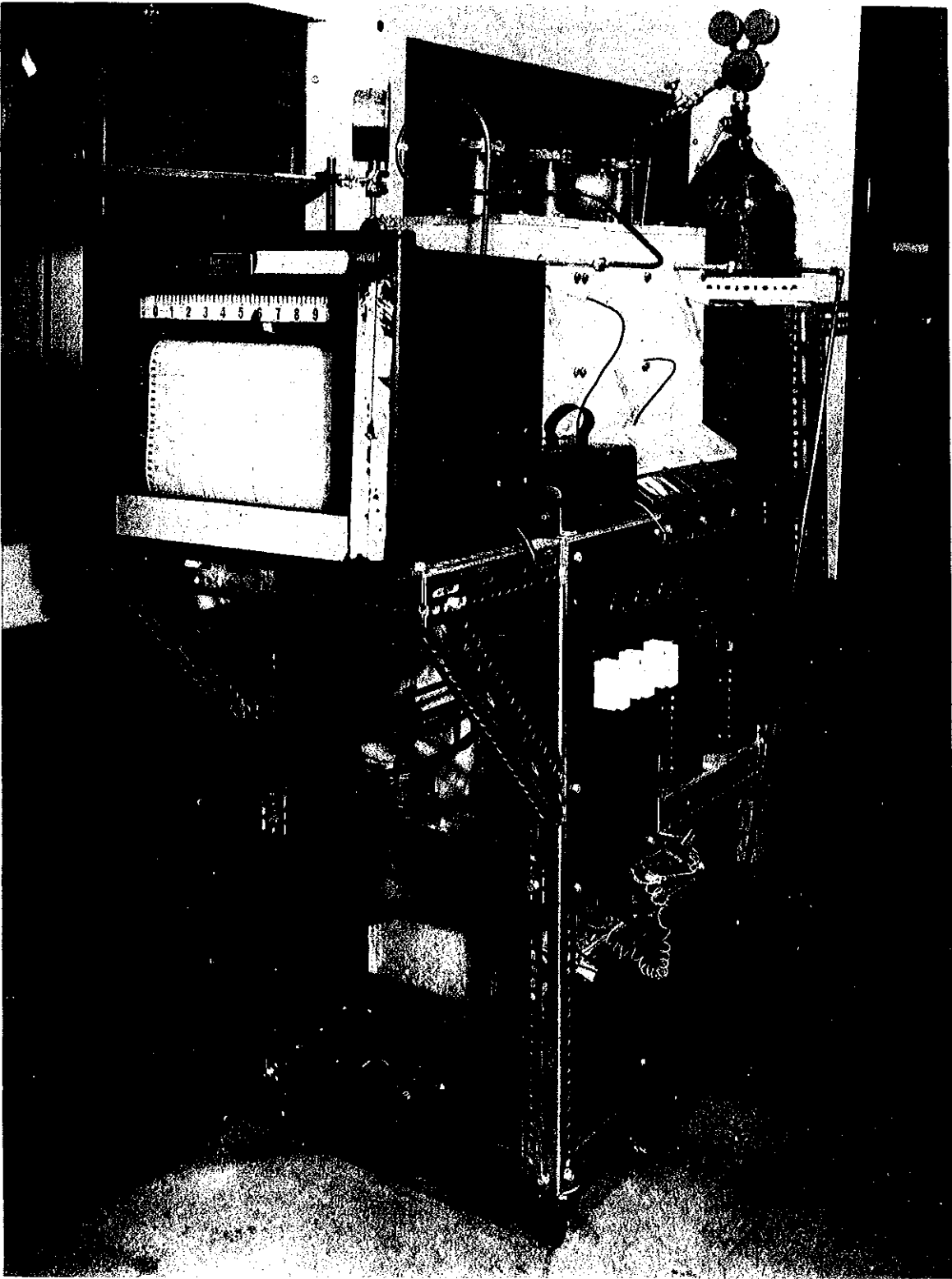

Fig. 8a. Argon purification unit.

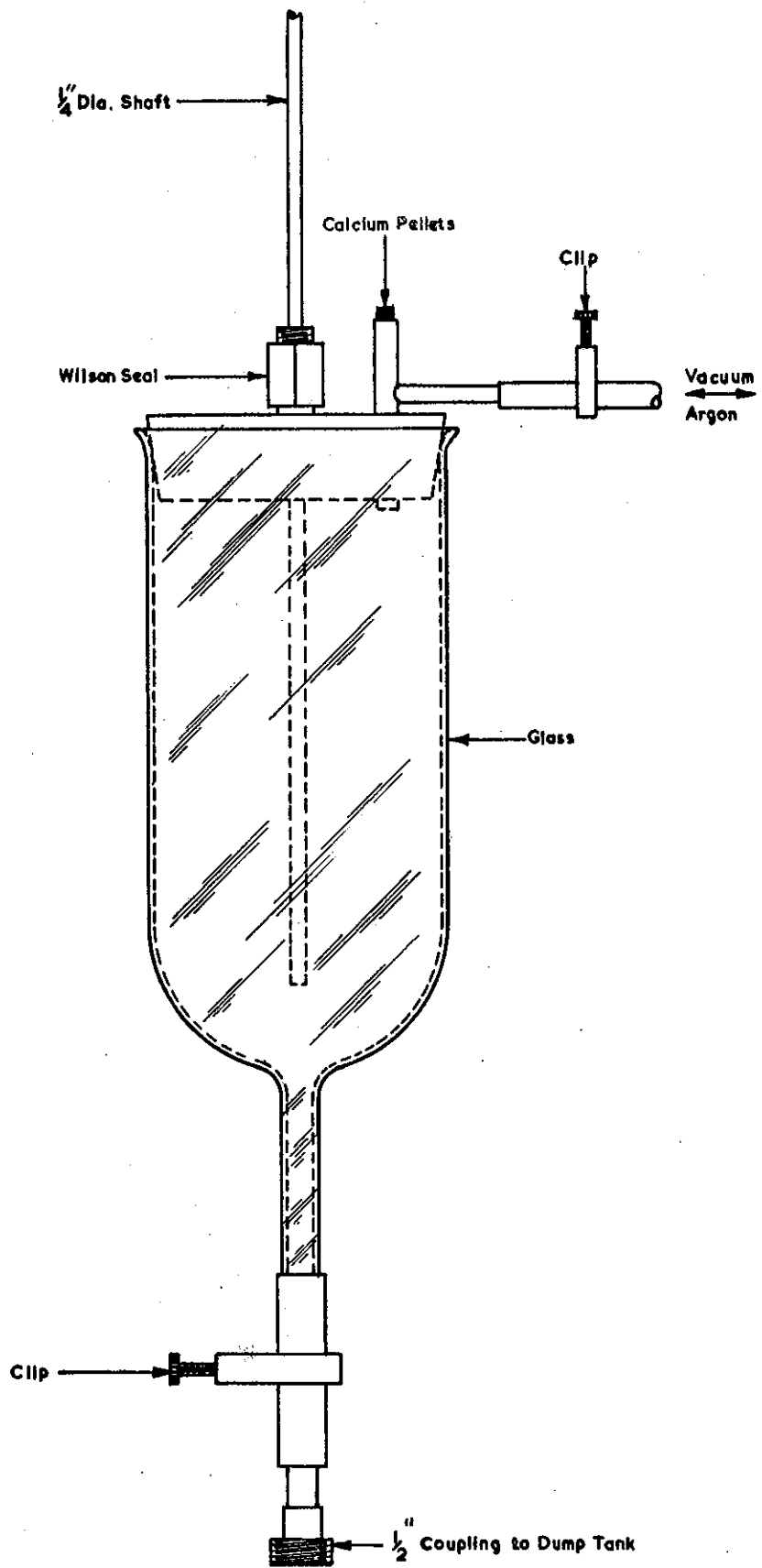

FIG. 9 APPARATUS FOR ADDING CALCIUM TO DUMP TANK

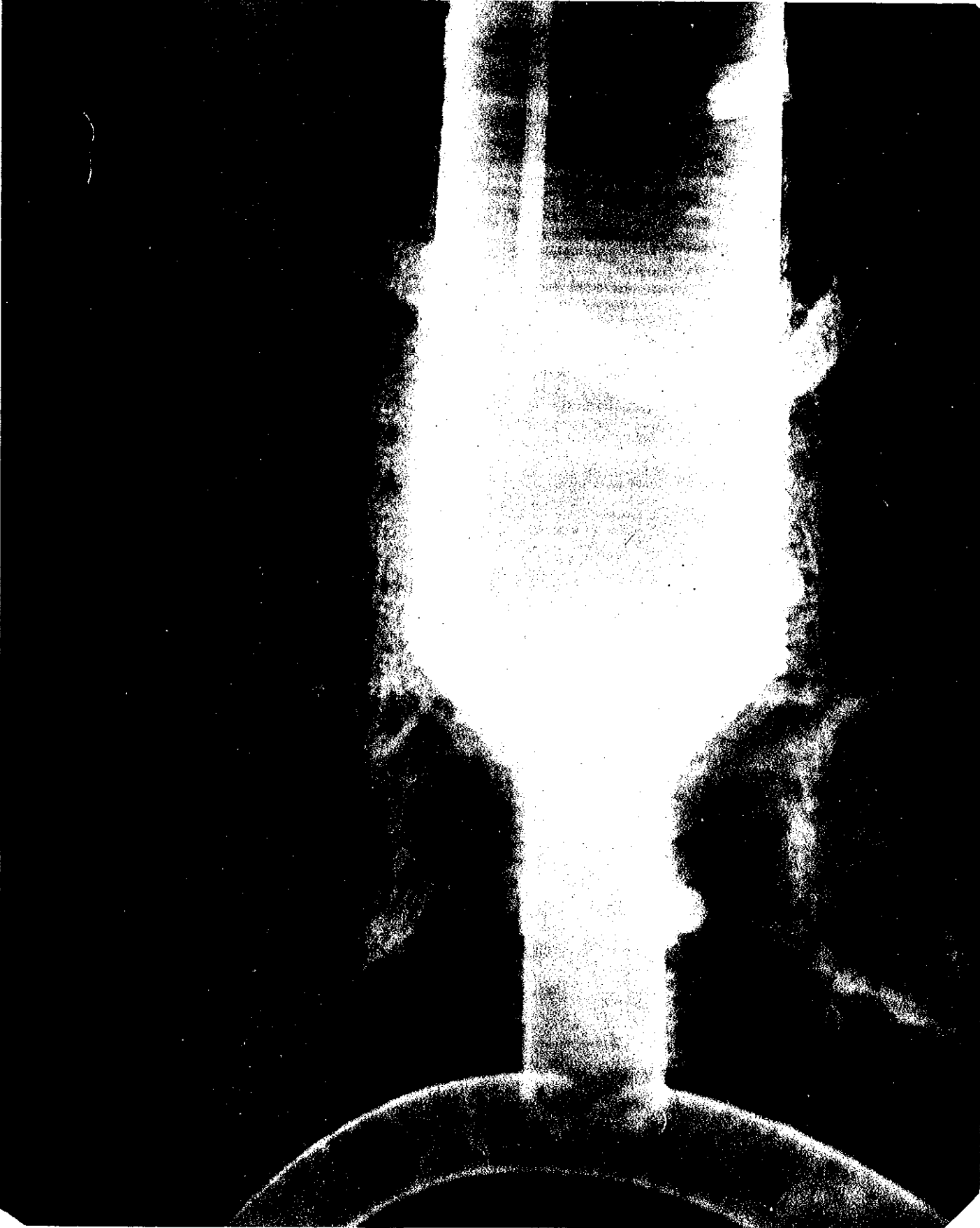

Fig.10. Radiograph showing position of uranium slug in the vent tank .

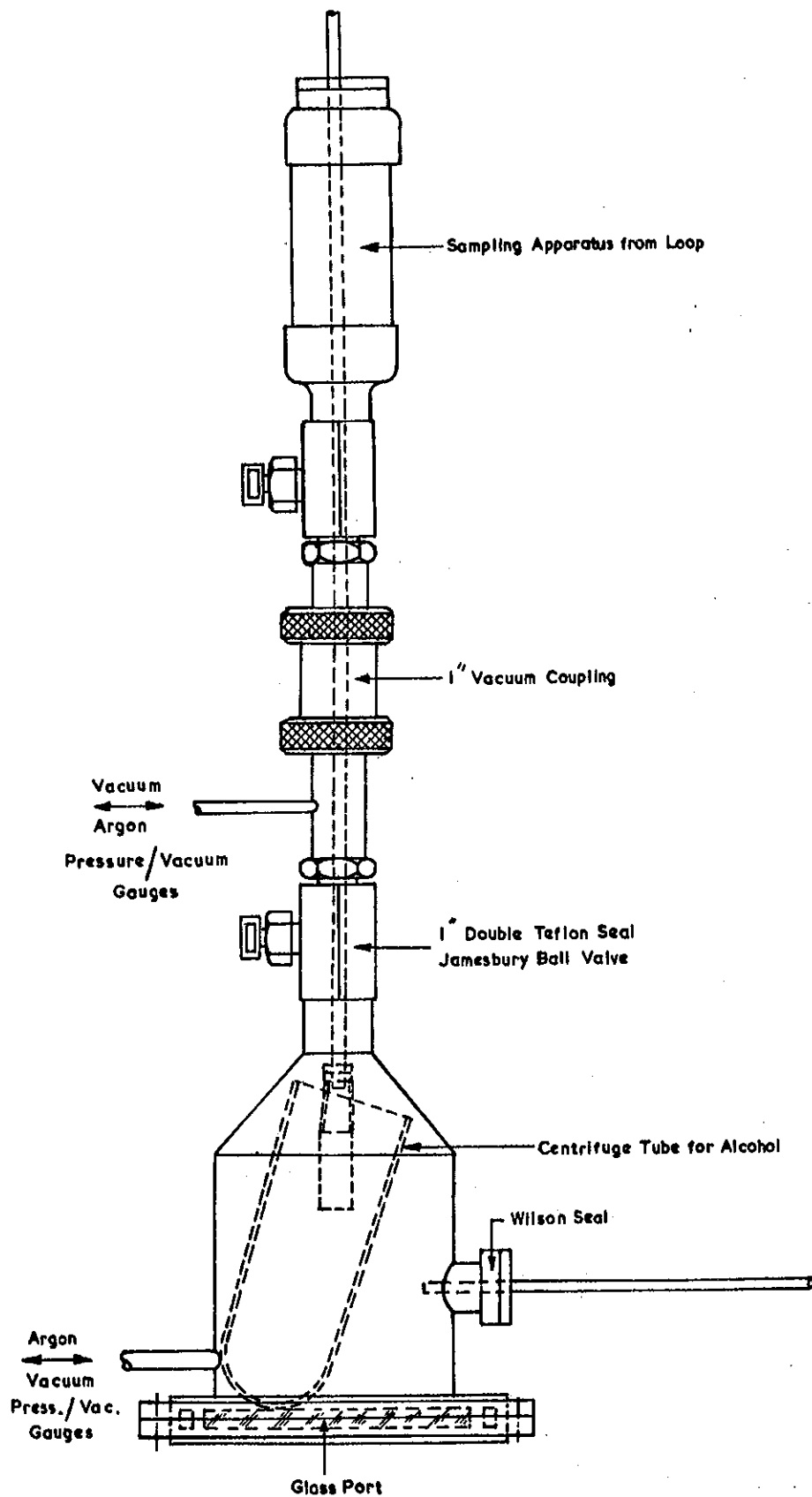

FIG. 11 APPARATUS FOR VIEWING AND CLEANING SPECIMENS AND SODIUM
SAMPLES UNDER VACUUM OR ARGON

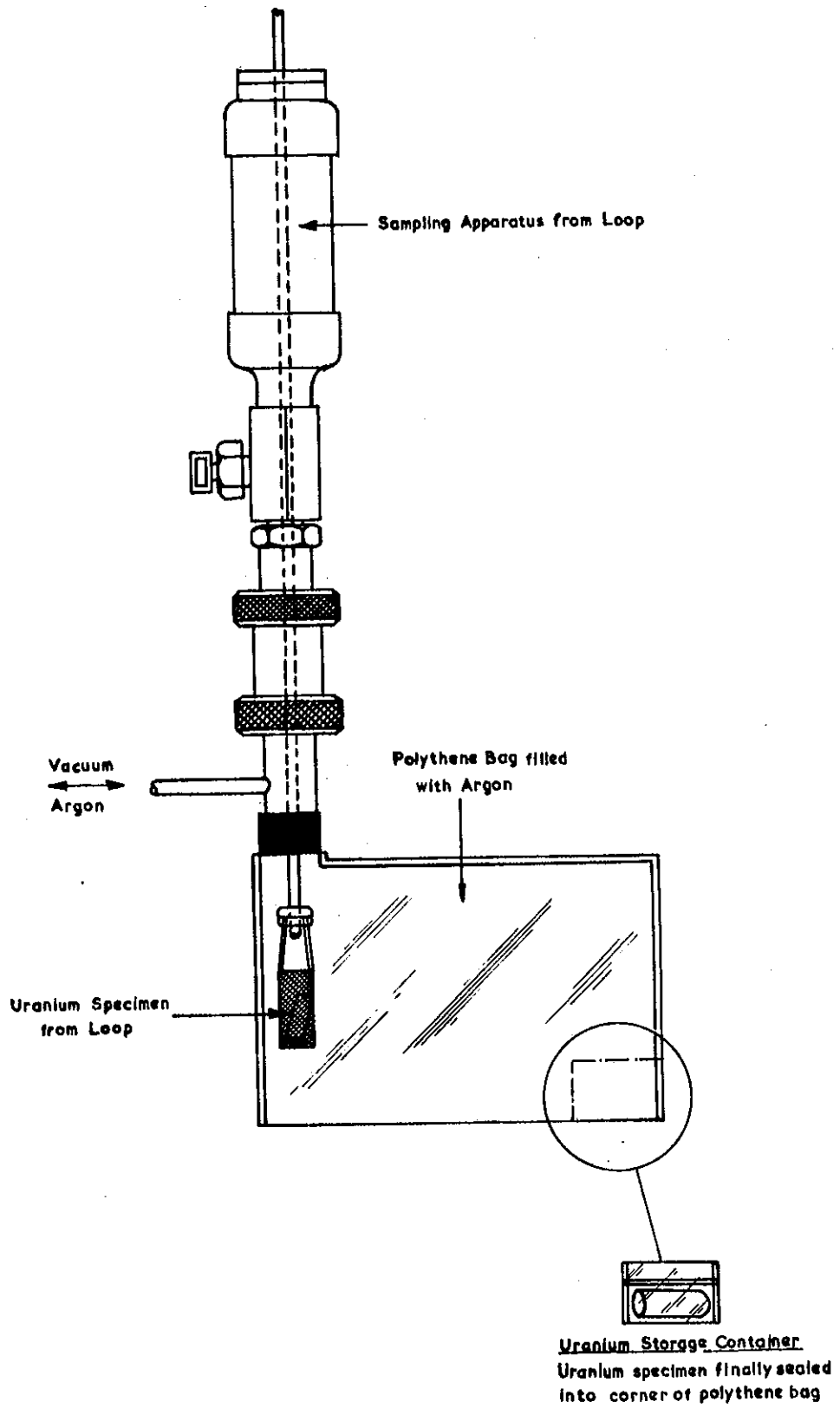

FIG.12. APPARATUS FOR THE TRANSFER OF URANIUM SPECIMEN FROM LOOP TO SEALED POLYTHENE STORAGE CONTAINER

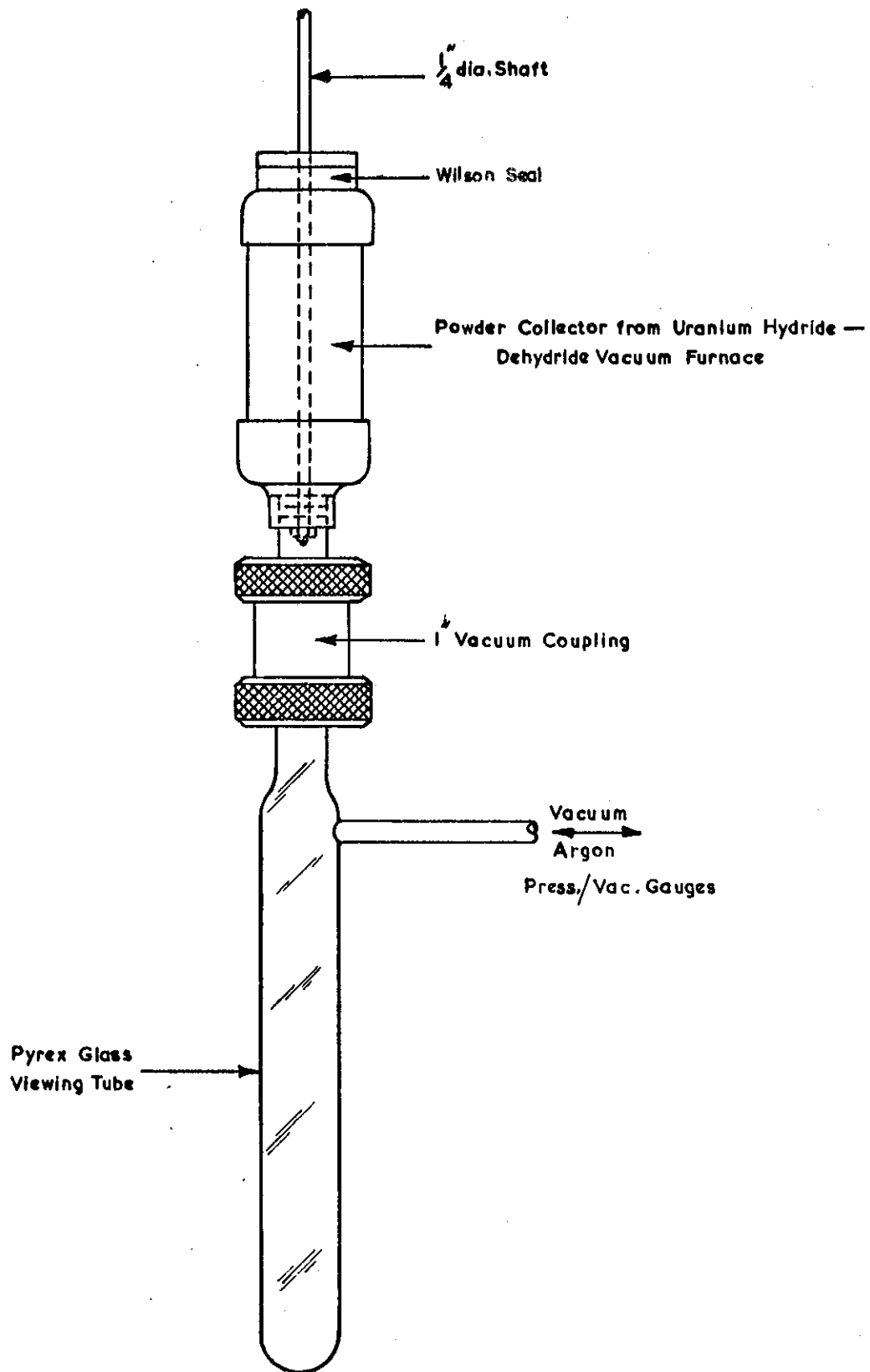

FIG. 13 APPARATUS FOR VISUAL OBSERVATION OF URANIUM POWDER

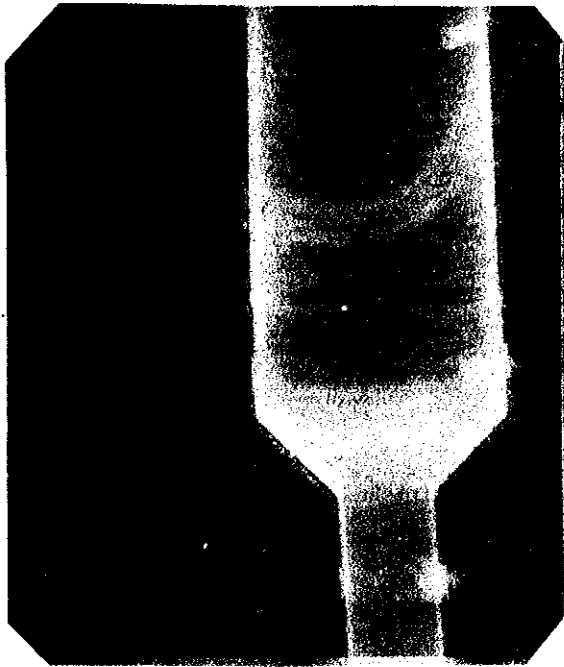

Fig.14 Radiograph showing uranium on shoulders of vent tank.

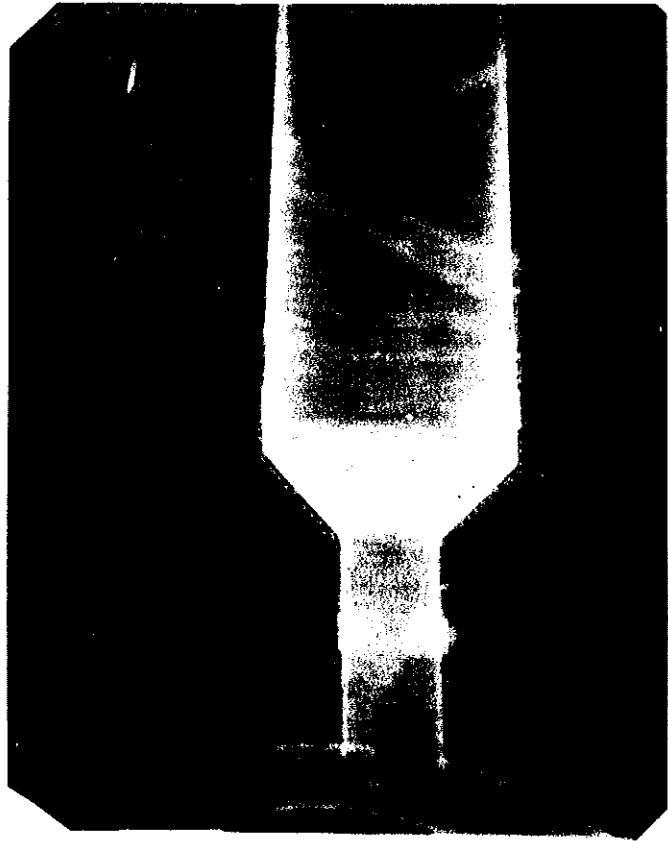

Fig. 15 Radiograph showing vent tank shoulders with uranium removed by tapping.

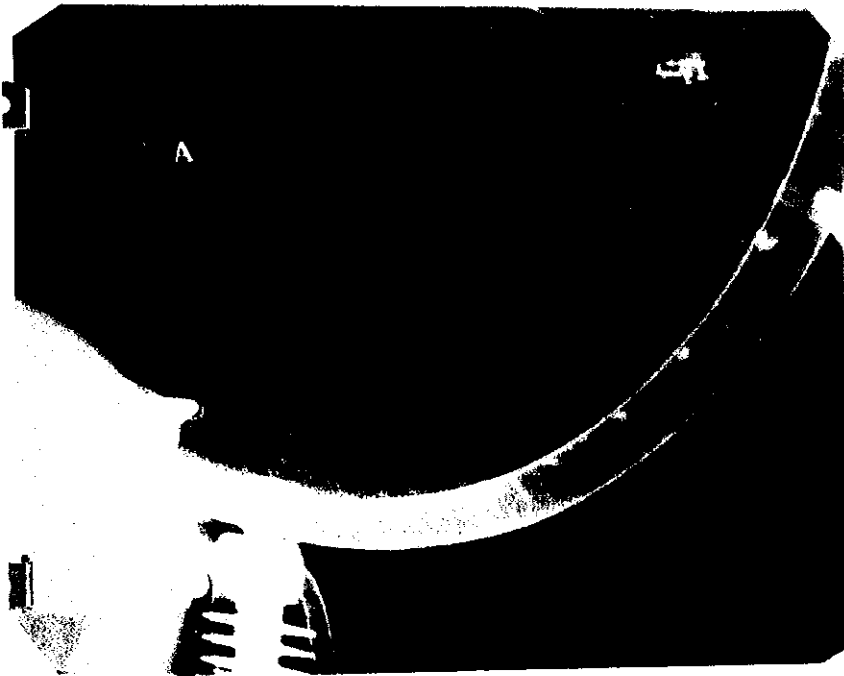

Fig.16 Radiograph of Loop bottom - no uranium has precipitated.

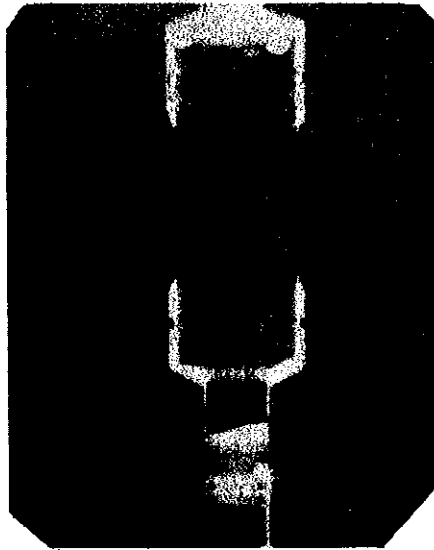

Fig. 17a

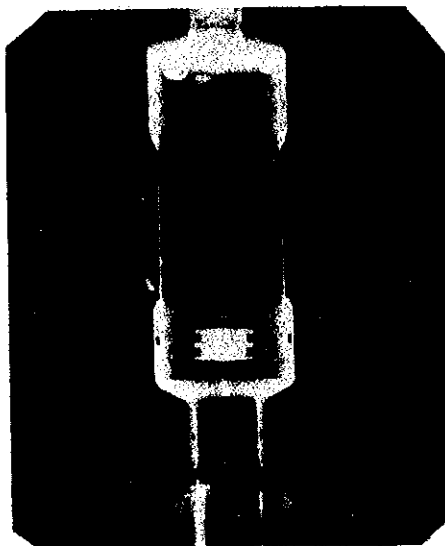

Fig. 17b

Fig.17 Radiographs showing uranium container (a) before and (b) after adding the powder to the Loop.

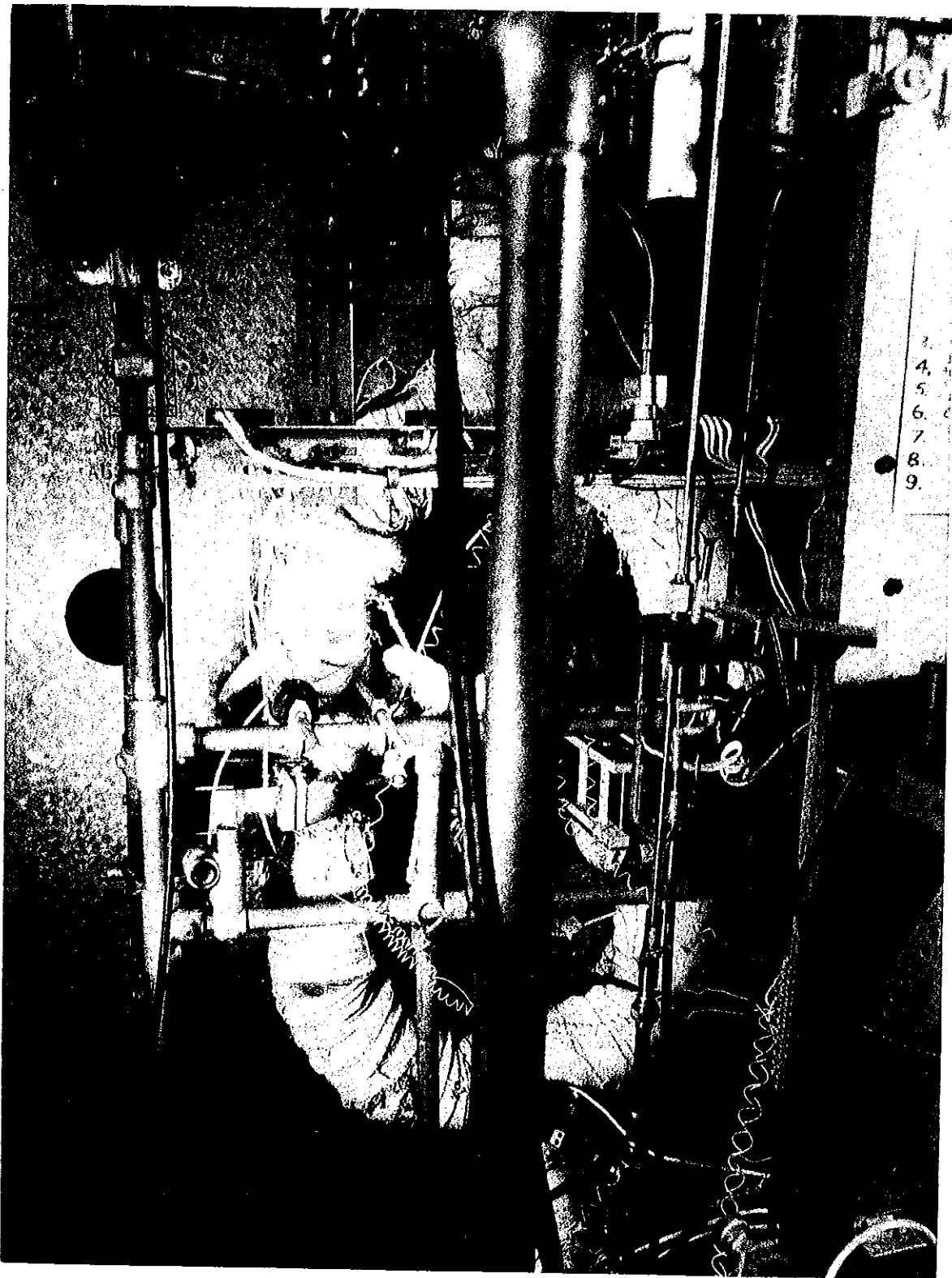

Fig.18 Close-up of Loop in enclosure .

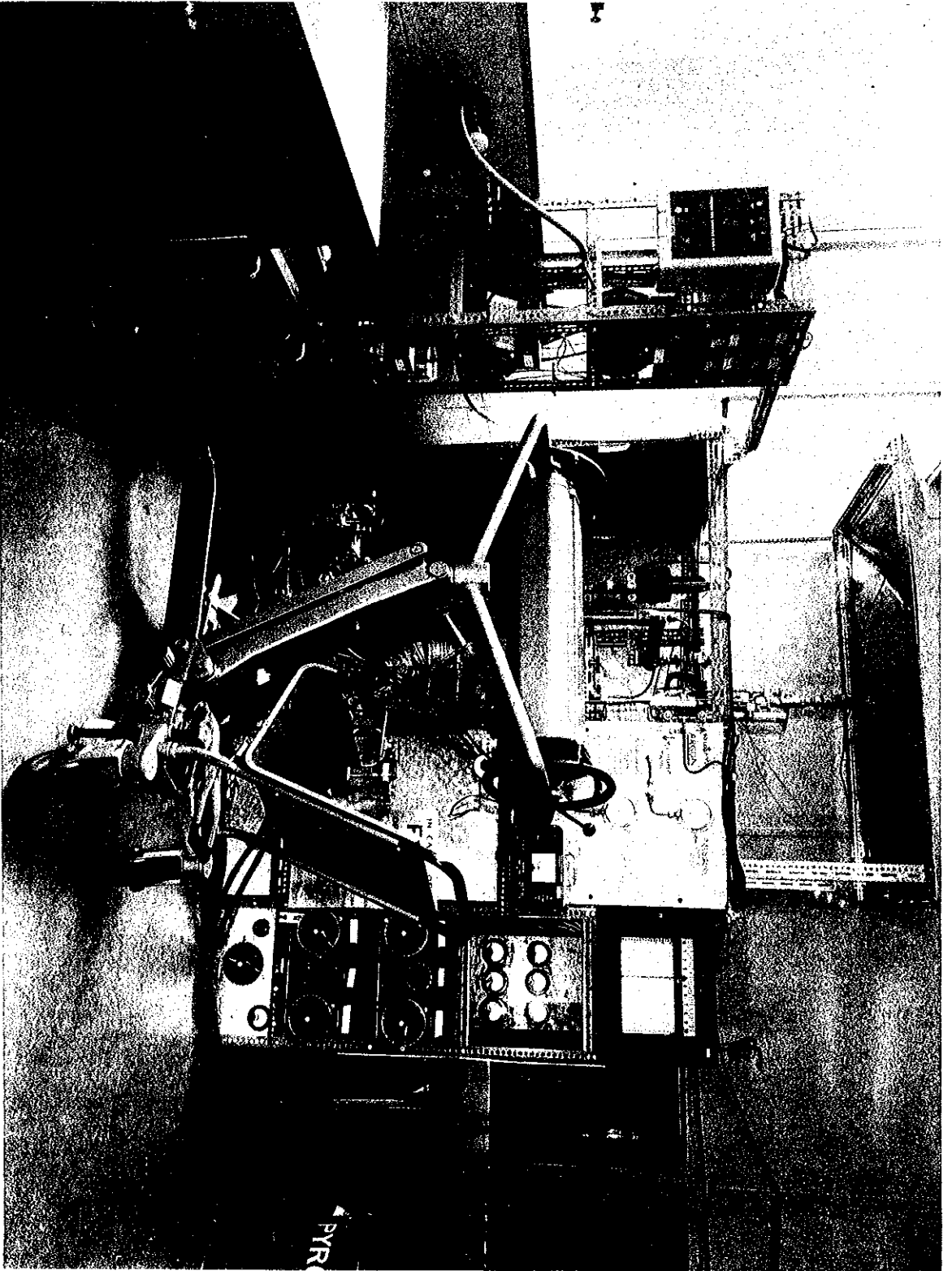

Fig. 19 Overall view of Loop enclosure. X-Ray set in foreground with uranium addition rig on top of Loop.

APPENDIX I

Electromagnetic Pump Details

Description: Single phase A.C. Electromagnetic Pump
Frazer-Nash Model Type 4.

Power Supply: 200 - 240 volts 50 - 60 c.p.s. mains.

Control: Maximum winding current 12.0 amps.
Control by varying output of auto transformer.

Operational temperatures: Primary winding 180°C.
Secondary copper turn brazed to stainless steel tube.
Melting point of braze 750°C.
Maximum liquid metal temperature 600 - 650°C
with auxiliary cooling to transformer windings.

APPENDIX 2

Details of Heaters

1. Loop Heaters

Top loop heater	2 kW	Ceramic bead insulated Nichrome
Bottom loop heater	2 kW	" " " "
Vent tank heater	500 W	" " " "
Top pump heater	250 W	" " " "
Bottom pump heater	250 W	" " " "

2. Auxiliary Heaters

Dump tank – side walls	500 W	Strip heaters
Dump tank – bottom plate	500 W	Pyrotanax
Dump valve block air heater	750 W	Pyrotanax
Flowmeter Venturi tube	500 W	Pyrotanax

Sodium Transfer Line Heaters

Connecting pipe – dump tank to loop	250 W	Ceramic bead insulated Nichrome
Connecting pipe – dump tank to filling tank	250 W	" " " "

3. Typical Auxiliary Heater Circuit

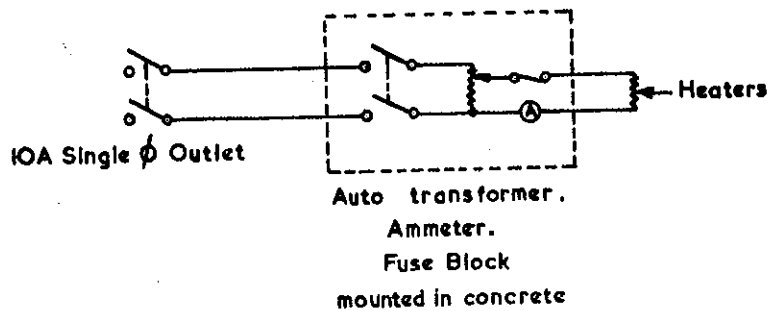

APPENDIX 3

Preparation of High Purity Sodium

The following operations were carried out in the order given to increase as far as possible the purity of the sodium entering the loop in the later runs:

- (i) Vacuum melting
- (ii) Calcium deoxidation
- (iii) Hydrogen dechlorination
- (iv) Low temperature filtration
- (v) Vacuum distillation

Further details of these operations are as follows:

1. Vacuum melting

Slow melting in a vacuum of approximately 10^{-3} mm mercury caused some breakdown of hydrides and hydroxides, with removal of hydrogen. Oils collected in storage were also largely removed. The impurities remaining for removal in later operations were thus reduced.

2. Calcium deoxidation

Early samples of vacuum distilled sodium (produced by the method of Horsley (1953) in the modified still shown in Figure 1) contained up to 80 p.p.m. of oxygen and it was necessary to further modify the design of the still to incorporate bellows-sealed valves (Bett and Kluss, 1960). Oxygen contents of the product sodium then dropped to approximately 20 p.p.m. as measured by the method of de Bruin (1960). Samples from Horsley's still contained between 20 and 80 p.p.m. oxygen, the difference between these figures and those claimed by Horsley being attributable to the levels of accuracy claimed for his analytical methods.

It was evident from the figure 20 p.p.m. oxygen that departures from equilibrium were preventing attainment of the theoretical oxygen limit of less than 1 p.p.m. claimed by Horsley. To bypass these side reactions, use was made of the fact that metallic calcium would reduce sodium oxide almost completely to sodium and calcium oxide. Calculations from thermodynamic data (Kubaschewski and Evans, 1951) showed that at 250°C , for every p.p.m. of calcium oxide dissolved in sodium containing excess calcium, the equilibrium concentration of sodium oxide would be 1.6×10^{-18} p.p.m.

Experiments showed that small amounts of calcium in sodium did not affect the compatibility of the sodium with the materials intended for investigation. Consequently calcium additions were dissolved in unfiltered sodium and the solutions soaked at $300 - 330^{\circ}\text{C}$ for 3 to 4 hours before being cooled prior to hydrogen dechlorination. Oxygen analyses of sodium heated with calcium and subsequently vacuum distilled were below the limit of detection (20 p.p.m.) and subsequent compatibility experiments indicated the oxygen levels to be below 1 p.p.m.

3. Hydrogen dechlorination

The chlorine content of early samples of vacuum-distilled sodium was found to run as high as 0.11 per cent. (cf. the theoretical upper limit of 3.5×10^{-1} p.p.m. suggested by Horsley (1953)). It was evident that non-equilibrium reactions were causing the high product chlorine content, and volatile chlorides were suspected in spite of the very high stability of sodium chloride (Gross and Levi, 1957).

APPENDIX 3 (continued)

A non-equilibrium reaction, hydrogen reduction of sodium chloride, was selected for trial as a method of removing chlorine from sodium based on the reported low solubility of hydrogen chloride in sodium (A.E.C., 1955).

Purified hydrogen was passed through sodium held at 250°C at a rate of approximately V/4 per minute (V being the volume of sodium). The effluent gas was observed after a certain period to satisfy spot tests for hydrogen chloride gas. The effluent gas continued to satisfy the spot tests for some time after which it suddenly ceased to do so.

The hydrogen treated sodium was then cooled, vacuum melted again, and then vacuum distilled. During the remelting in vacuum considerable volumes of hydrogen were evolved from the sodium. The chlorine analysis of the vacuum distilled sodium was found to run below 1 p.p.m.

Hydrogen treatment of sodium at 250°C followed by vacuum distillation thus reduces the chlorine content of the sodium to a very low figure. While investigation of the mechanism of this reaction was outside the scope of the work, it is interesting to note the induction period of the reaction, the definite reaction period, and the subsequent considerable hydrogen content of the sodium. It is possible that the induction period corresponded to the build-up time for a reactant in the sodium, (e.g. sodium hydride) to a critical level. When this level was reached, the reduction reaction could proceed. The overall reaction would thus be limited initially by hydrogen activity in sodium and then by chlorine activity in the sodium. The reactions should then be

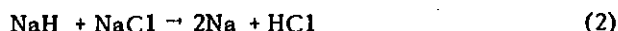

Reaction (2) would depend for forward progress on the rate of reaction of hydrogen chloride gas with sodium being sufficiently slow to allow part of the hydrogen chloride gas to be removed on formation from the reaction zone by the hydrogen stream. The presence of calcium was found to have no effect on the reaction.

4. Low temperature filtration

Filtration at 120-130°C was used to remove particulate matter from the sodium. The low temperature was selected in order to avoid solution of impurities as much as possible. A steel wool filter plug was used, as porous metal filters were found to block too readily and did not in any case out-perform a tightly rammed plug of steel wool. (They had the additional advantage of being easily removed for cleaning).

5. Vacuum distillation

This method has been described by Horsley (1953) as excellent for reducing contaminant concentration to a low level. It was used as a final stage purification and yielded typical final product analyses as follows:

O₂ undetectable, Cl₂ < 1 p.p.m., N₂ up to 20 p.p.m.,
Ca 300 p.p.m., K 65 p.p.m.,

F.T. - Al, Mg, Fe, Cd

V.F.T. - Cu, Si, Su, Pb

Absent - Li, Be, Sr, Ag, Cr, Ba, P, As, B, Bi, Au, Zn,
Hg, Ti, V, Zr, Mo, W, Mn, Co, Ni, Th.

N.B. the spectrographic analysis levels for F.T. correspond to approximately 0.01 per cent. and for V.F.T., 0.002 per cent.

APPENDIX 3 (continued)

To maintain this degree of purity it was found necessary to handle this sodium only under specially purified inert atmospheres in carefully cleaned compatible containers, e.g. of 18/8/1 austenitic stainless steel. Glass containers were not satisfactory.

References

- A.E.C. - Dept. of Navy, 1955. Liquid Metals Handbook, Sodium - NaK Supplement, TID-5277, July, 1955.
- Bett, F.L., and Kluss, T.N., 1960. Demountable vacuum valves for use with liquid metals. Internal report AAEC/TM43.
- de Bruin, H.J., 1960. Determination of traces of oxygen in sodium metal by infrared spectrophotometry. *Analytical Chemistry*, 32: 360.
- Gross, P. and Levi, D.C., 1957. Extraction and refining of the rarer metals. Institution of Mining and Metallurgy, London, February, 1957.
- Horsley, G.W., 1953. The purification of sodium by vacuum distillation. A.E.R.E. M/R1152.
- Kubaschewski, O., and Evans, L.L., 1951. Metallurgical thermochemistry. Butterworth, Springer Ltd., London.

Acknowledgments

To the Analytical Chemistry Section, A.A.E.C. for the analytical work reported.

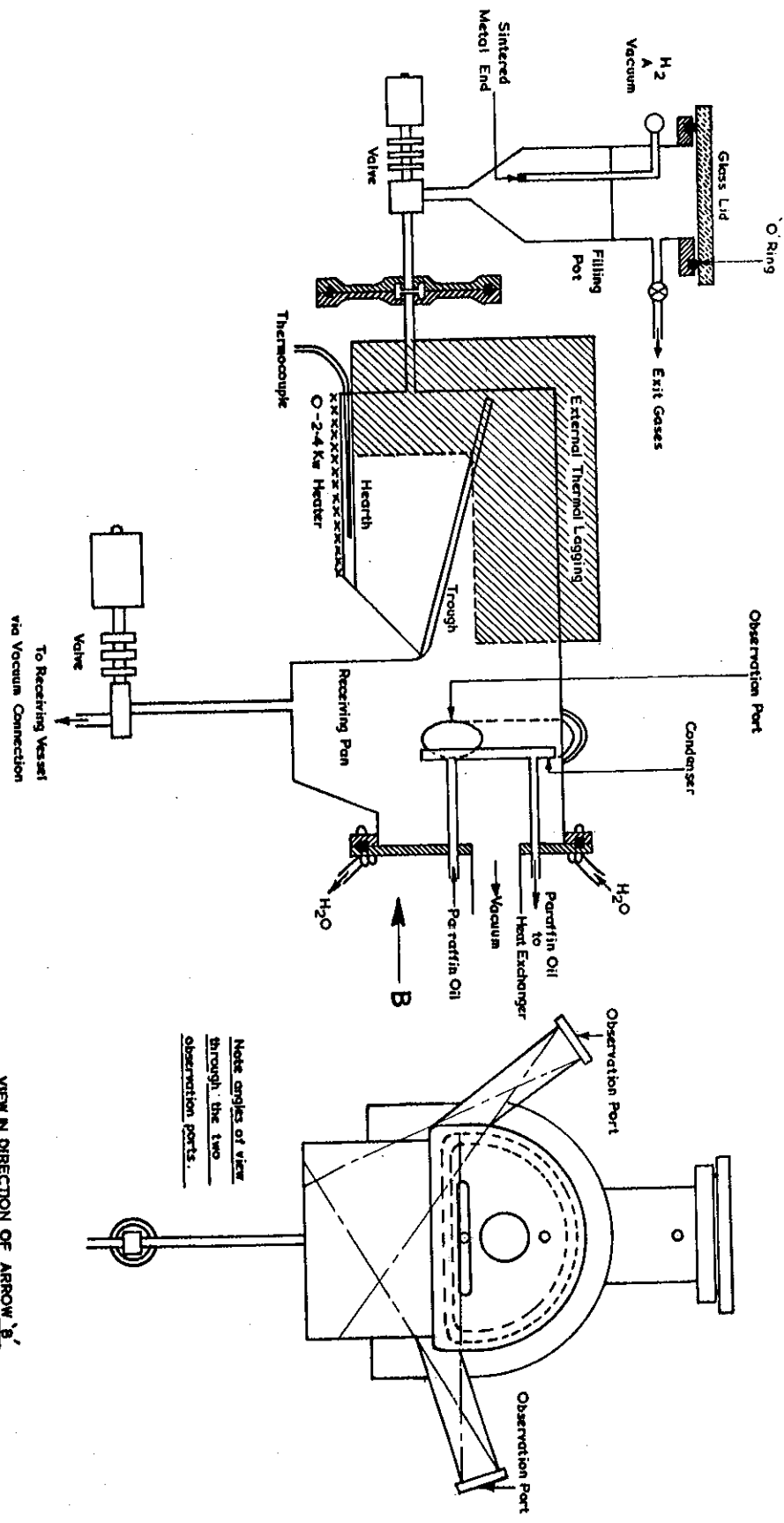

Note angles of view
through the two
observation ports.

SECTIONAL ELEVATION
APPENDIX 3 FIG. 1 A.E.R.E.-TYPE VACUUM DISTILLATION UNIT FOR SODIUM PURIFICATION

VIEW IN DIRECTION OF ARROW 'B'

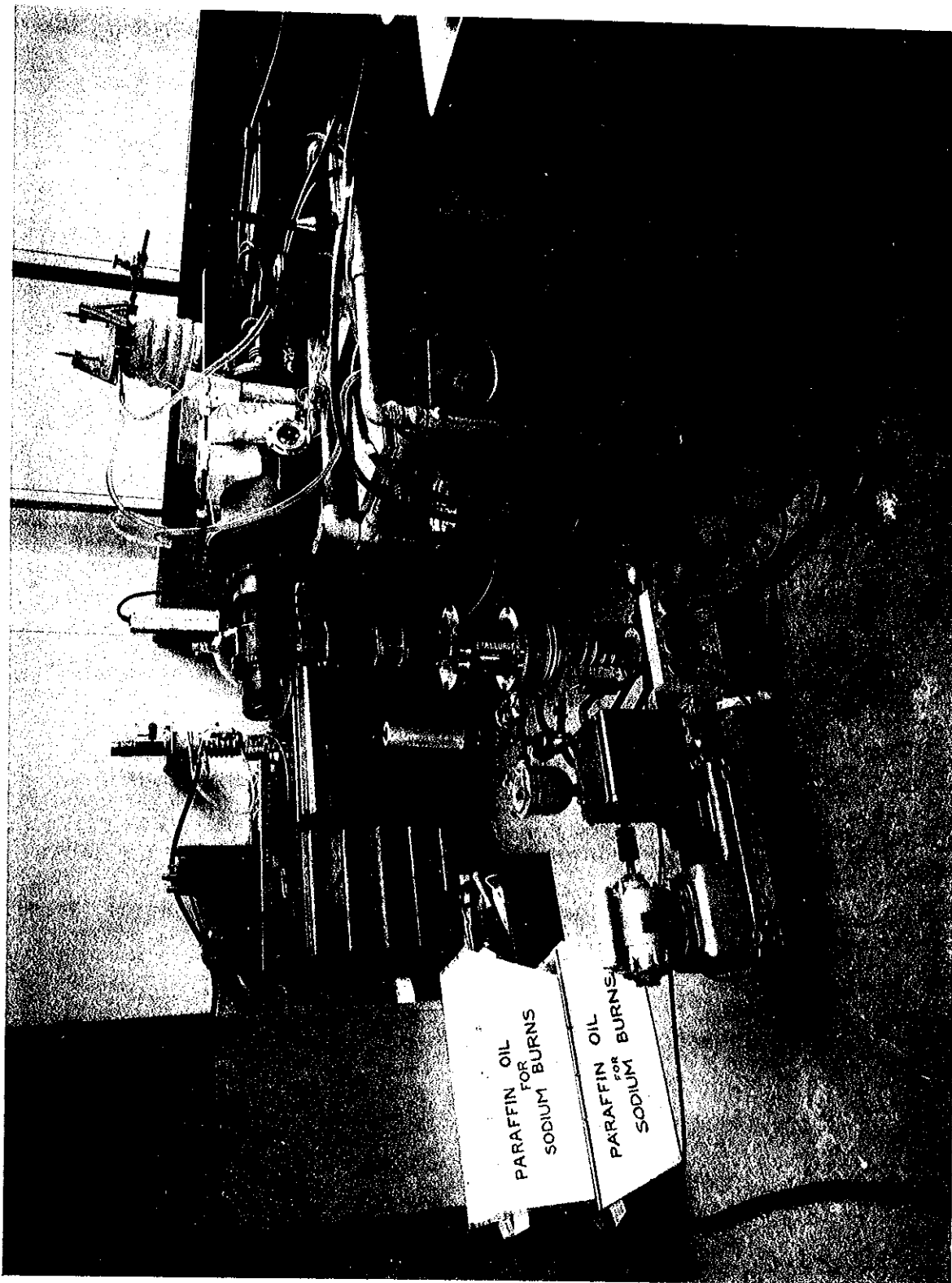

APPENDIX 3. FIG 2. SODIUM PURIFICATION APPARATUS

APPENDIX 4

Operating Experience with the Loop

Table 1 gives a summary of loop operation. The following features of operation are worth noting:—

- (1) It was possible to operate the autotransformers supplying the heaters for long periods at or slightly above their rated currents and switch them at full current if adequate air-cooling was available. Inspection of the autotransformers at the conclusion of 4,320 hours of operation revealed no signs of damage.
- (2) Line voltage in the laboratory was changed so much by the switching ON and OFF of the loop heater windings during controlled operation that a voltage stabilising transformer was installed to give steady conditions in the electromagnetic pump.
- (3) Loop temperature changes caused considerable flux changes in the gap of the electromagnetic flowmeter. These changes were calibrated in terms of temperature and allowance made in calculating velocity. Variations of 3 per cent. occurred with an increase of magnet pole temperature of 25°C.
- (4) The sensitivity of the smoke alarm was excellent. From the experience gained with it, this type of alarm is recommended as of great value in installations handling liquid sodium where there is a fire risk.
- (5) Oil in compressed air lines caused two oil fires in the loop enclosure with the inevitable loop shut-down in each case. Oil traps should therefore be included in air lines when the air is used for cooling very hot objects.
- (6) Loop start-up after such shutdowns was a simple procedure as follows: With controllers set at 300°C and with the pump control set at 40 volts primary, the loop was soaked for approximately 24 hours. The sodium would then have completely melted and would commence flowing. Powder could be resuspended by an appropriate increase in sodium velocity.
- (7) Loop filling was difficult because, in such a small yet extended system, great care was necessary to avoid a rapid passage of sodium into the loop with a chance of a carry over into the vacuum system. This was avoided finally by calculating the pressure differential necessary to raise the given head of sodium at the chosen temperature, attaining the temperature in the loop and dump tank, and then setting the appropriate pressure difference. The sodium would then rise slowly without splashing and stop at the correct level. This method was very satisfactory.
- (8) Deposition of uranium powder in the vent tank could be prevented by tapping the tank. Manual tapping was tiresome and of limited application. A satisfactory tapping machine was constructed from a 240 volt fire alarm bell contacting the vent tank through a freely suspended anvil of mild steel bar.